

# ROADS IN THE LAND OF LANKERSHIM RANCH LAND

AS PER MAP IN BOOK 31 PG. 39 to 44 MISC. R.

RE-SURVEYED AUG. 1895

BY  
*E. T. Wright*  
COUNTY SURVEYOR

Scale: 1 inch = 4 chains

FIELD BOOK NO. 2 PAGES 55 to 64  
COUNTY SURVEYOR'S MAP NO. 4132

(Formerly C.S. Map No. 2283)

Retraced from the cloth mounted egg-shell  
original map which has been discarded

I.M. 54

Pacoima Ave. chg. to Laurel Canyon Blvd. - Ord. 6-713

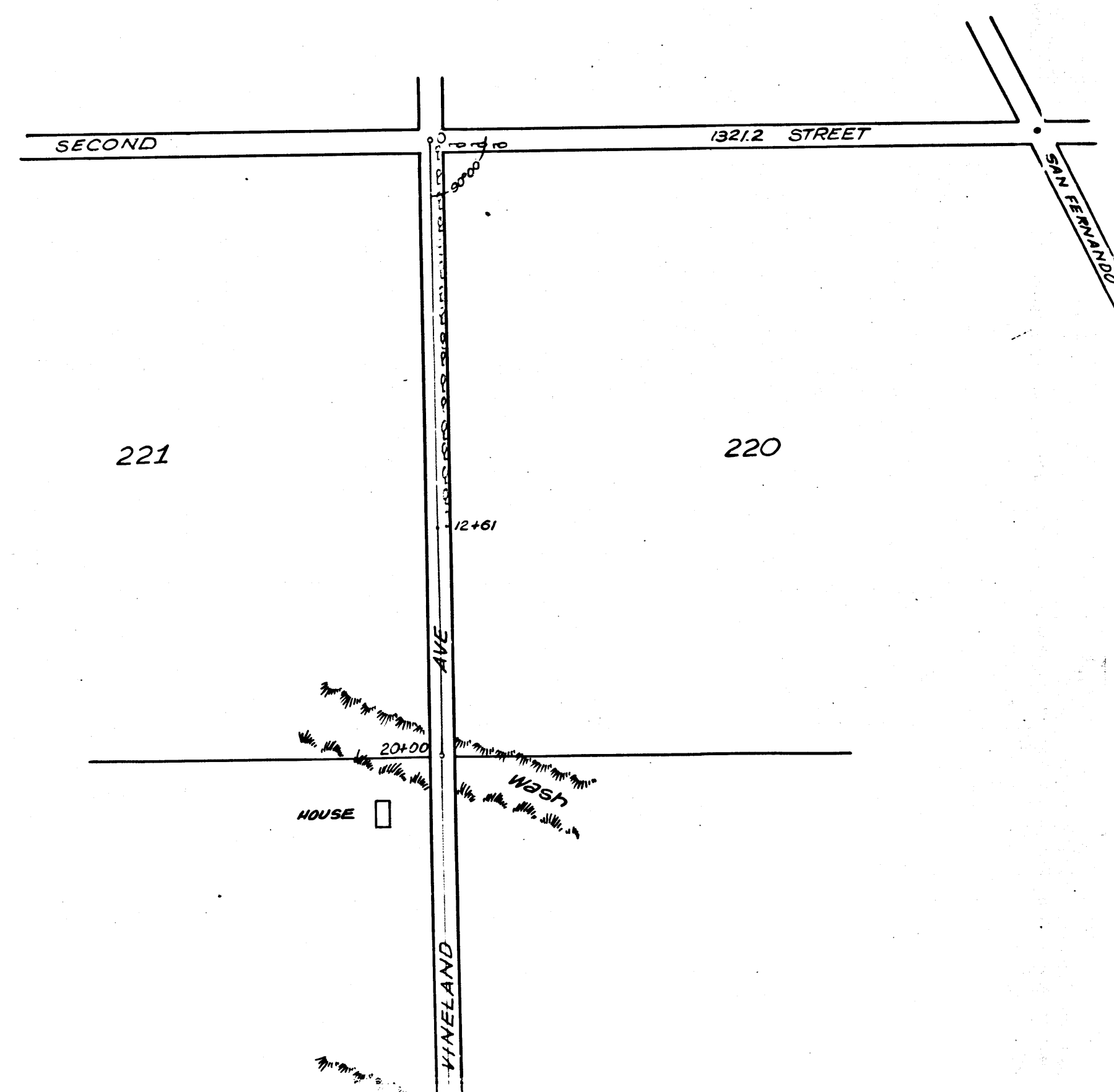
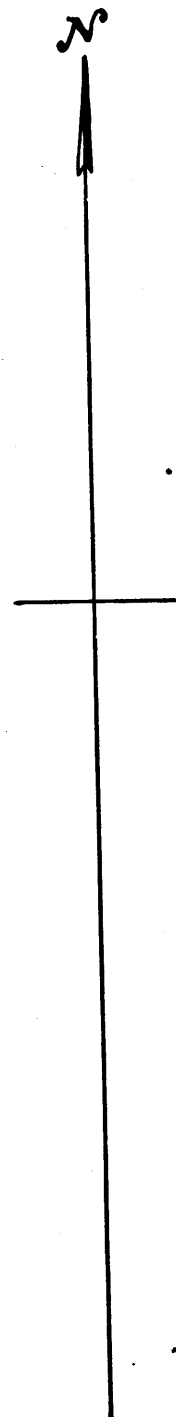
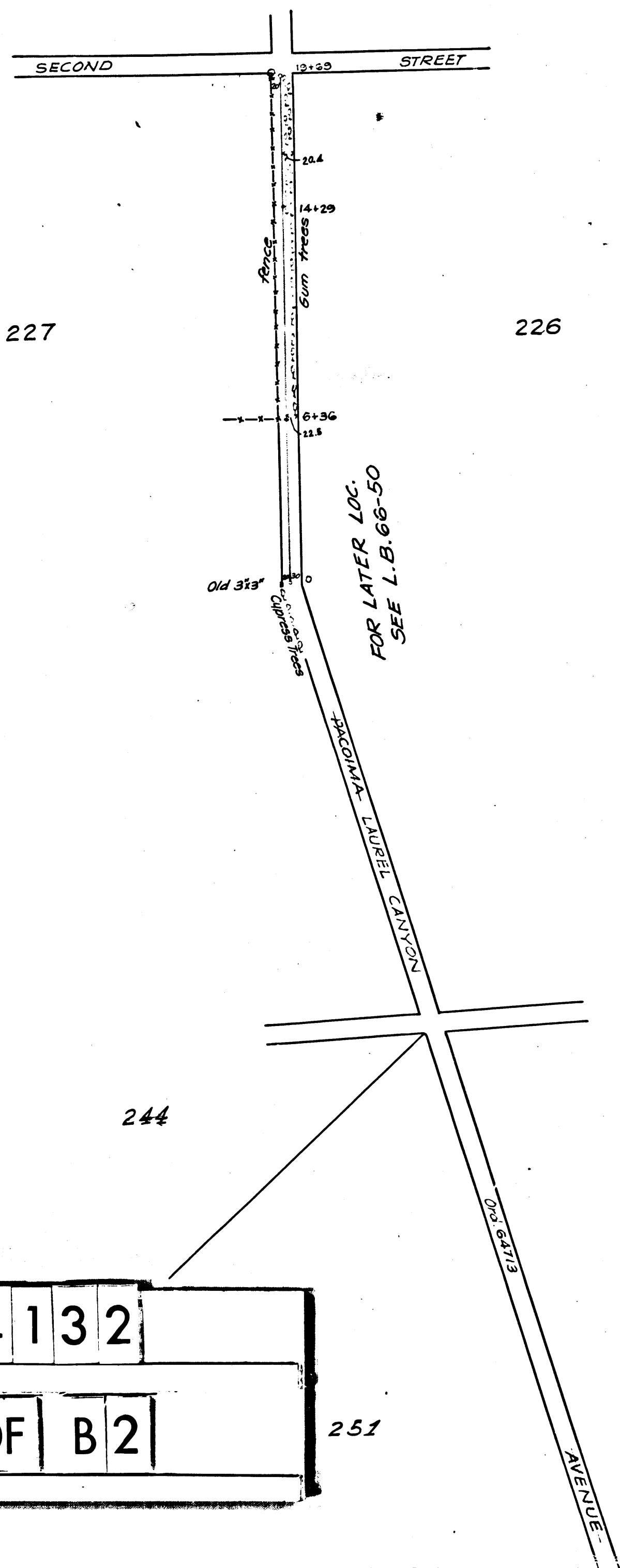

CS	4	1	3	2
A1	OF	B2		

# ROADS

IN THE LAND OF

## LANKERSHIM RANCH LAND AND WATER CO.

AS PER MAP IN BOOK 31 PG. 39 to 44 MISC.REC.

RE-SURVEYED AUG. 1895

BY  
*E. T. Wright*  
COUNTY SURVEYOR

Scale: 1 inch = 4 chains

FIELD BOOK NO. 2 PAGES 55 to 64  
COUNTY SURVEYOR'S MAP NO. 4132  
(Formerly C.S. Map No. 2283)

Retraced from the cloth mounted egg-shell  
original map which has been discarded

I.M. 54

traced by - *Shank Was*, April 1958  
checked by - *R.J.B.*

Pacoima Ave. chg. to Laurel Canyon Blvd. - Ord. 64713

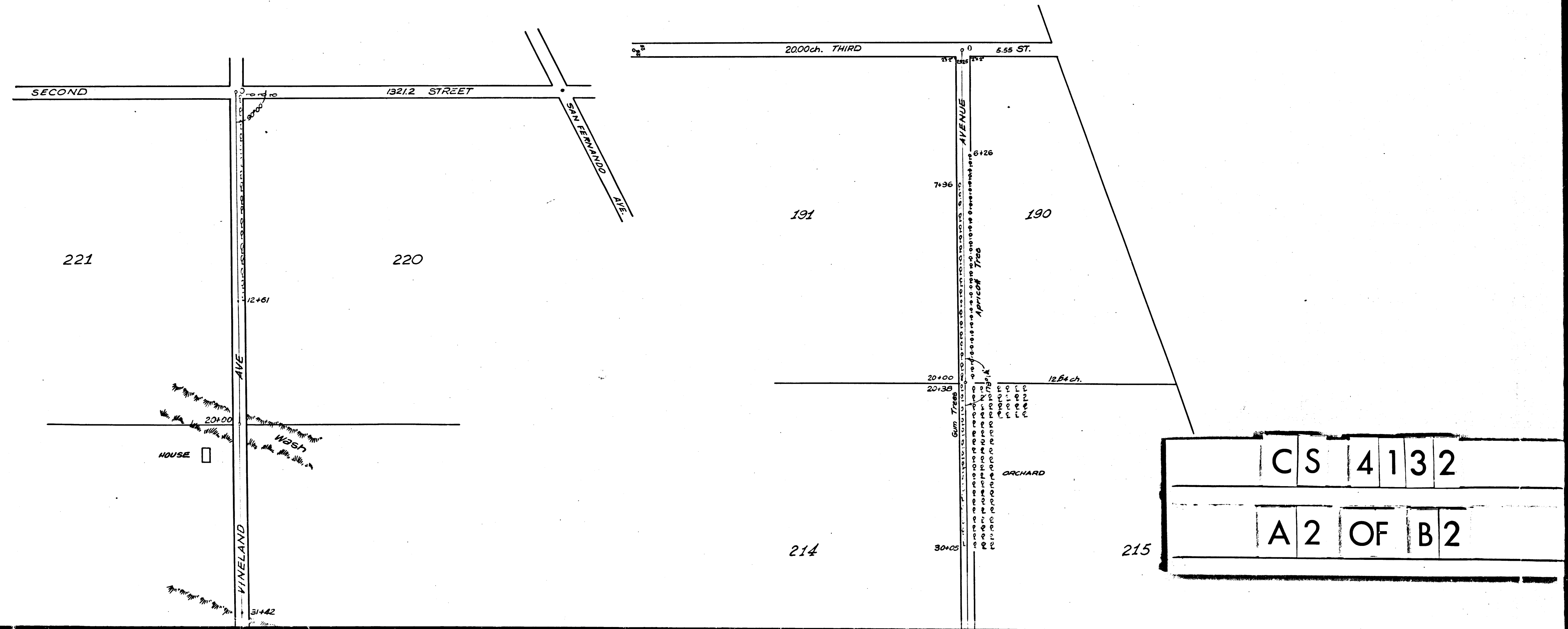

C	S	4	1	3	2
A	2	O	F	B	2

244

251

252

250

253

249

254

221

220

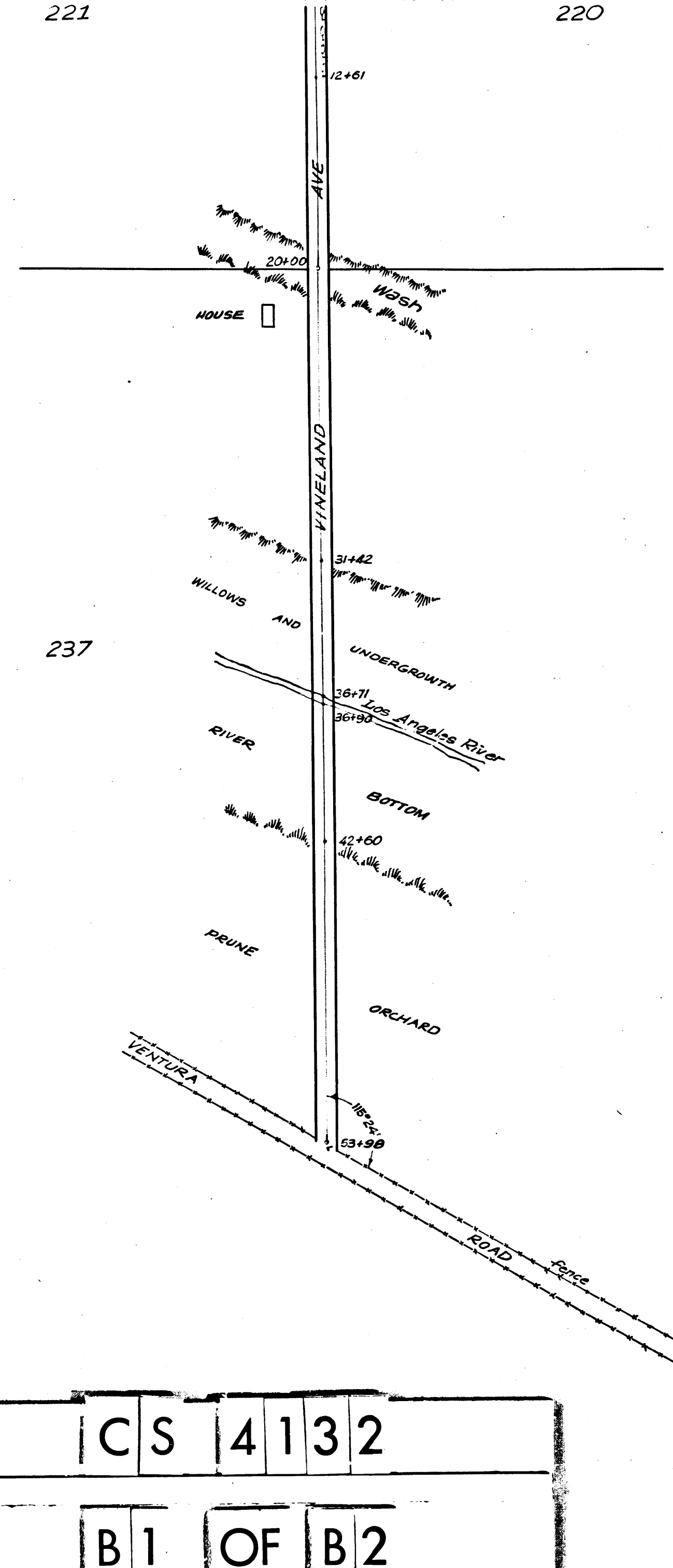
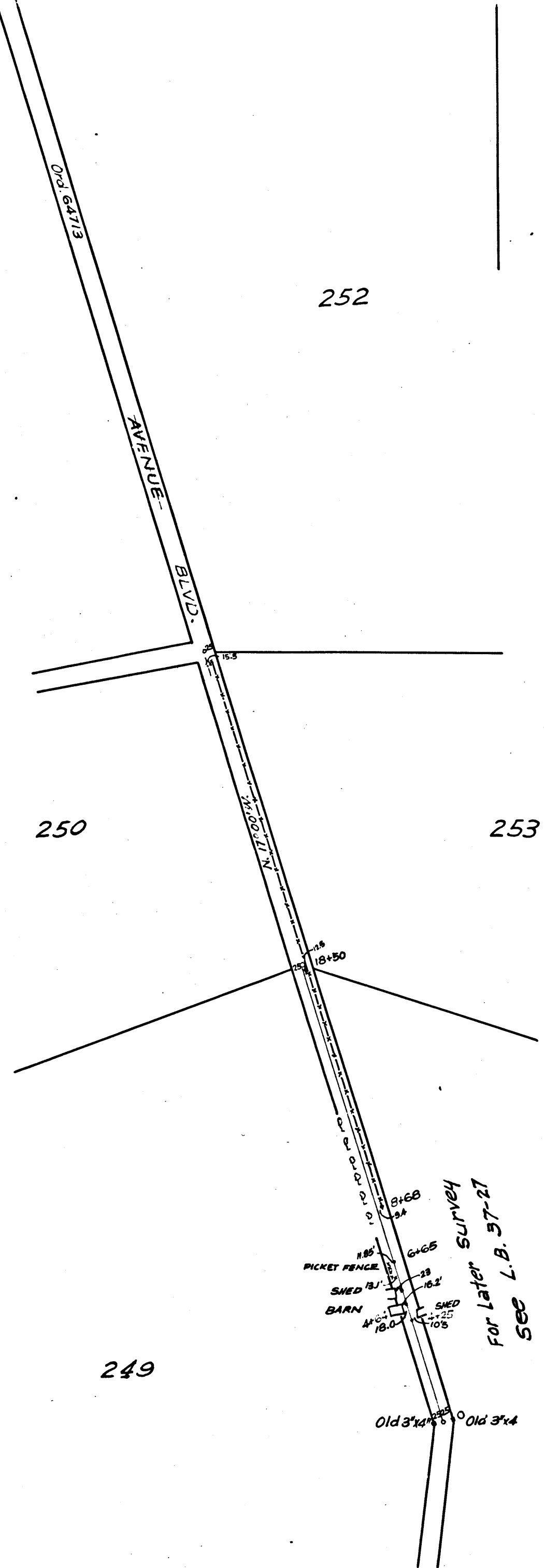

C	S	4	1	3	2
B	1	OF	B	2	

Old 3'x4'

Old 10'x5'

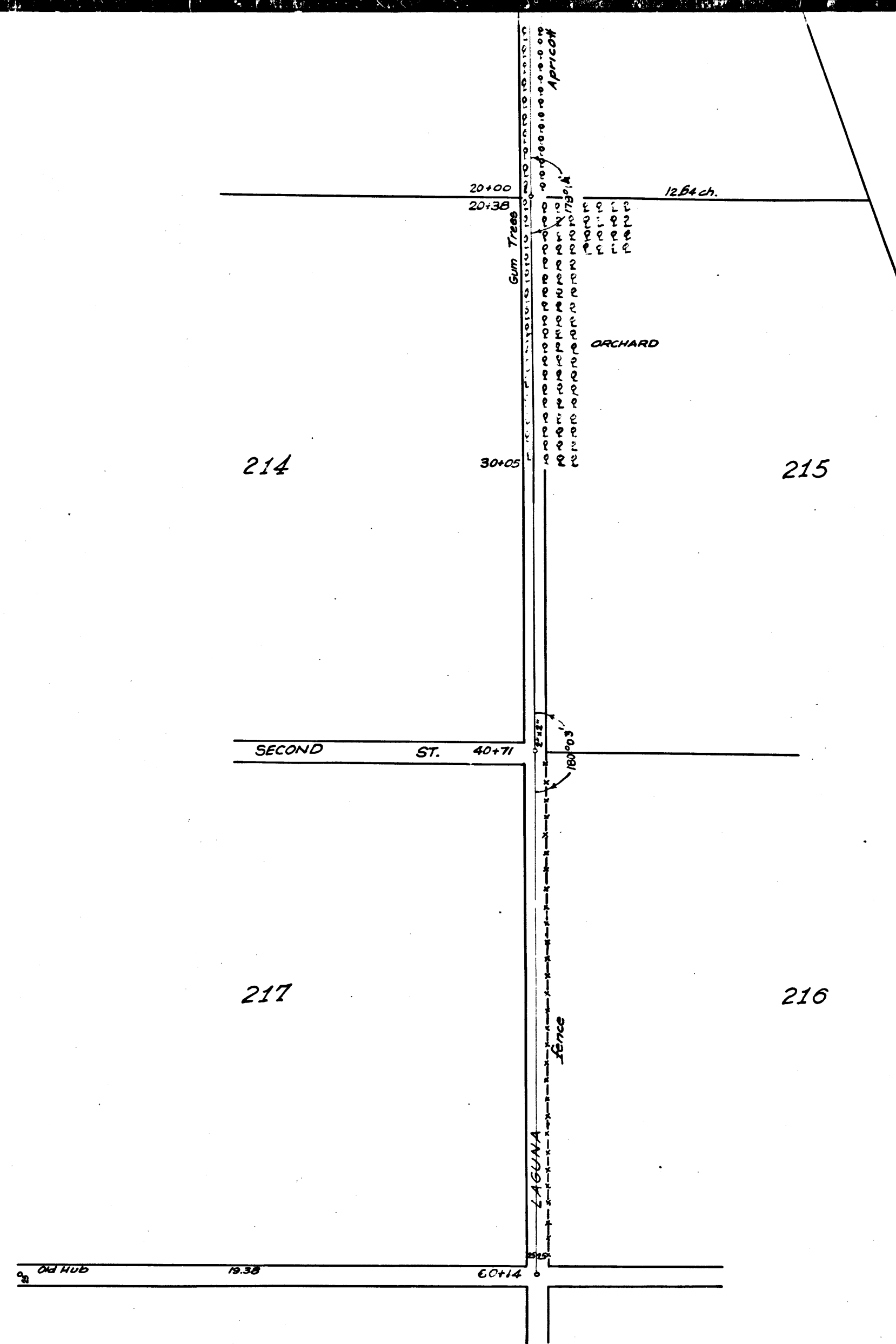
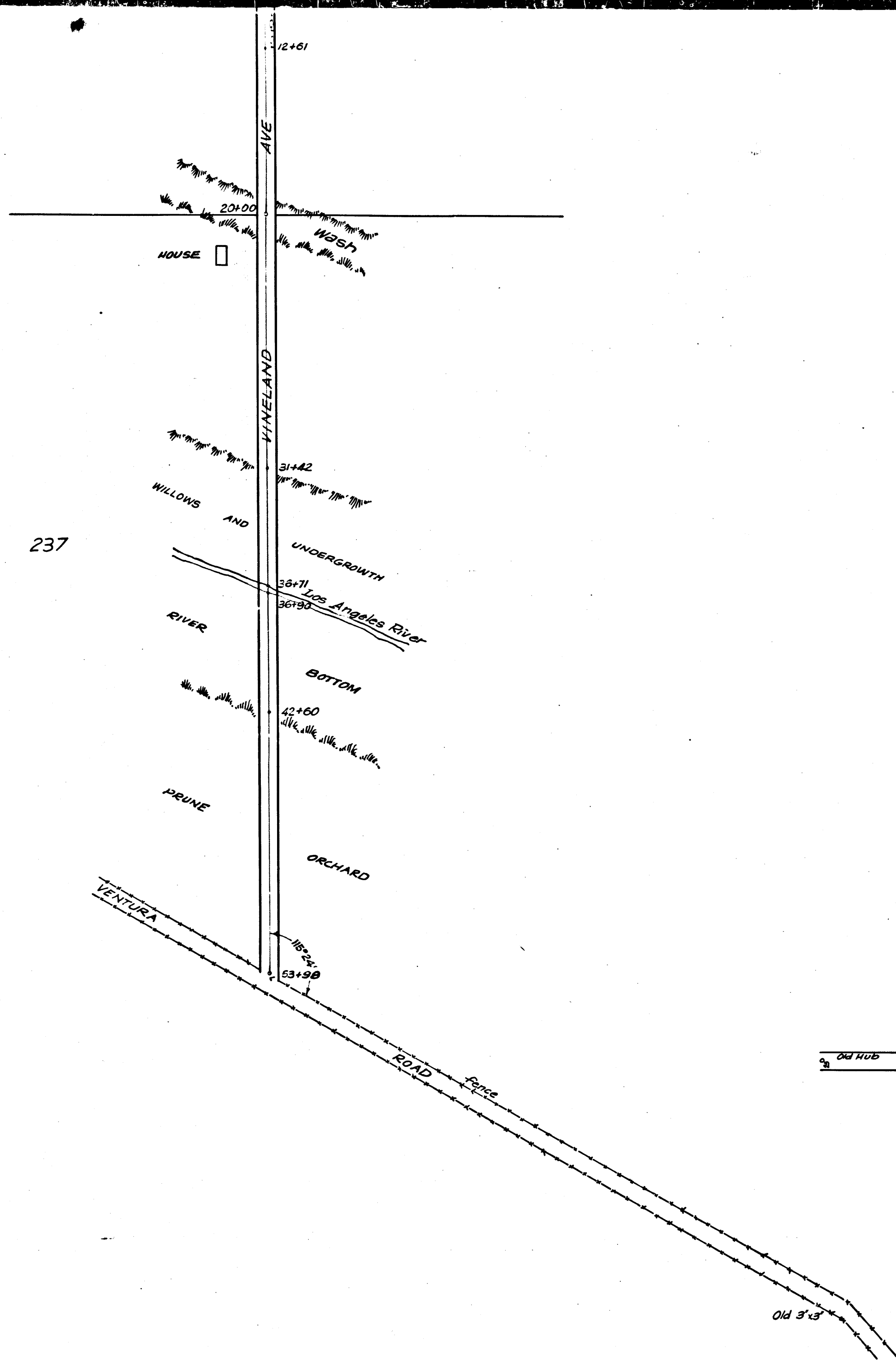

254

CS	4	1	3	2
B	2	OF	B	2