

Los Angeles County Flood Control District

DESIGN MANUAL

DEBRIS DAMS AND BASINS



Howard H. Haile, Chief Engineer

**2250 Alcazar Street, Los Angeles
Telephone: (213) 226-4111**

**P. O. Box 2418, Terminal Annex
Los Angeles, California 90051**

PREPARED BY DESIGN DIVISION

James L. Easton, Division Engineer

Supervised By:

C. W. Hallstrom Supervising Civil Engineer III
K. Senzaki, Supervising Civil Engineer II

Participating Divisions:

Design
Hydraulic
Materials Engineering
Operation and Maintenance
Project Planning

CRITERIA FOR DESIGN OF DEBRIS DAMS AND BASINS

The following text and exhibits have been prepared as a guide for design, preparation of plans and specifications, and construction of debris dams and basins constructed by others for transfer to the District for maintenance.

TABLE OF CONTENTS

<u>Description</u>	<u>Page</u>
Section A - Design of Debris Dams and Basins	
A-1 Basin Design	A-1
A-1.1 General	A-1
A-1.2 Basin Capacity	A-1
A-1.3 Debris Volume	A-1
A-2 Earth Dam Design	A-2
A-2.1 General	A-2
A-2.2 Foundation and Abutments	A-2
A-2.3 Percolation Path at Dam Contact Areas	A-2
A-2.4 Crest of Dam	A-2
A-2.5 Protection for Dam Slopes	A-3
A-2.5.1 Upstream Face	A-3
A-2.5.2 Downstream Face	A-3
A-2.5.3 Slope Protection Gutter	A-3
A-3 Access to Dam and Basin	A-3
A-4 Access Road Gutter	A-4
A-5 Earthwork for Debris Dams and Basins	A-4
A-6 Gage Board Pipe Supports	A-4
A-7 Debris Barrier	A-4
A-7.1 General	A-4
A-7.2 Location and Spacing of Barrier	A-5
A-7.3 Design of Barrier Member	A-5
A-7.4 Selection of Barrier Member	A-6
A-8 Right of Way	A-6
A-8.1 General	A-6
A-8.2 Right of Way Limits	A-6
A-9 Fencing	A-6
A-10 Debris Disposal Area	A-6
Section B - Subsurface Investigation Report	
B-1 Field Investigation	B-1
B-2 Subsurface Report	B-1
B-2.1 General	B-1
B-2.2 Detailed Recommendations	B-2
B-3 Exploratory Borings	B-2
B-3.1 Location and Number of Borings	B-2
B-3.2 Depth of Borings	B-3
B-3.3 Type of Borings	B-3
B-4 Logs of Boring and Location Map	B-4
B-4.1 General	B-4
B-4.2 Ground Water	B-4
B-5 Samples	B-4
B-6 Laboratory Analyses	B-5
B-6.1 Required Analyses	B-5
B-6.2 Notes Pertaining to Laboratory Analyses	B-7

<u>Description</u>	<u>Page</u>
Section C - Engineering Geology Investigation Report	
C-1 Field Investigation	C-1
C-2 Geologic Report.....	C-1
C-2.1 General.....	C-1
C-2.2 Detailed Information.....	C-2
Section D - Structural Design Criteria	
D-1 General.....	D-1
D-2 Allowable Stresses	D-2
Section E - Design of Rectangular Spillway	
E-1 Hydraulic Design.....	E-1
E-1.1 Spillway Design Q's	E-1
E-1.2 Spillway Requirements.....	E-1
E-1.3 Freeboard.....	E-1
E-2 Structural Design	E-1
E-2.1 Method of Design.....	E-1
E-2.2 Horizontal Loads.....	E-2
E-2.2.1 Spillway Empty.....	E-2
E-2.2.2 Spillway Full.....	E-3
E-2.2.3 Stability and Sliding.....	E-3
E-2.3 Vertical Loads.....	E-3
E-2.4 Soil Pressure.....	E-3
E-2.5 Construction Joints.....	E-3
E-2.5.1 General	E-3
E-2.5.2 Transverse Construction Joints	E-3
E-2.5.3 Longitudinal Construction Joints	E-4
E-2.6 Thickness of Members.....	E-4
E-2.7 Placement of Steel Reinforcement.....	E-4
E-2.7.1 Steel Clearances	E-4
E-2.7.2 Transverse Reinforcement	E-5
E-2.7.3 Longitudinal Reinforcement.....	E-5
E-3 Subdrains	E-5
Section F - Outlet Works	
F-1 General.....	F-1
F-2 Outlet Tower	F-1
F-3 Outlet Pipe.....	F-2
Section G - Specifications	
	G-1
Section H - Construction Requirements	
H-1 General.....	H-1
H-2 Construction Reports	H-1
H-3 Supplemental Information and Recommendations	H-1
H-4 "As Built" Drawings.....	H-2

INDEX OF CHARTS AND DRAWINGS

<u>Description</u>	<u>Page</u>
Maps of Debris Production Zones	I-1
Debris Production Curves	I-4
Slope Protection and Access Road Gutter Details.....	I-6
Typical Spillway and Outlet Works.....	I-7
Facing Slab Details	I-8
Gage Board Pipe Support Details	I-9
Spillway Subdrain Details.....	I-10
Graph for Determination of Creager's Q	I-11
Moment and Shear Curves for Spillway Walls	I-12
Moment and Soil Pressure Curves for Invert Slab of Rectangular Spillways.....	I-13
Drawing No. 2-D 178 Showing Details for Right of Way Fencing.....	I-29
Drawing No. 2-D 404 Showing Structural Details for Outlet Works	I-30
Drawing No. 2-D 413 Showing Unified Soil Classification System.....	I-31

SECTION A

DESIGN OF
DEBRIS DAMS AND BASINS

SECTION A

DESIGN OF DEBRIS DAMS AND BASINS

A-1 Basin Design

A-1.1 General

The volume of debris to be impounded shall be the amount generated from the watershed upstream of the selected site as indicated on the debris production curves.

Generally, the bottom of the basin shall be established at the average slope of the original stream bed. If extensive excavation below stream bed level is a design requirement, an inlet structure shall be provided at the upper end of the basin to prevent erosion of the stream bed upstream of the basin.

The cut slopes of the excavated basin shall be no steeper than that recommended by the soil engineer in his subsurface investigation report. Extensive cut slopes shall be protected against erosion from surface runoff from the surrounding area above by a "U" shaped protective gutter (Type B) around the perimeter of the cut area. (See Figure 1, page I-6).

The basin design shall include an access ramp to the bottom of the basin from the crest of the dam for debris removal purposes.

The sizing of the basin to contain the volume of debris to be impounded by the dam is accomplished by trial and error. The designer should be aware that certain dams as defined in the "Statutes and Regulations Pertaining to Supervision of Dams and Reservoirs" published by the State Department of Water Resources, Division of Safety of Dams, will fall under the jurisdiction of the State.

A-1.2 Basin Capacity

The required debris capacity for design of the basin shall be determined from the Debris Production Zones and the Debris Production Curves developed by the District and shown on pages I-1 through I-5. Because it is possible to have drainage area conditions which may affect the use of the curves, it is recommended that confirmation as to application of the curves be obtained from the District.

A-1.3 Debris Volume

The calculations for the debris volume shall be based on the assumption that the debris will be deposited in such a manner that the debris slope, sloping upstream from the spillway crest, will be equal to 50 per cent of the average slope of the original stream bed for the total length of the basin site.

SECTION A Continued

A-2 Earth Dam Design

A-2.1 General

The height of the dam is measured vertically from the spillway crest to the natural bed of the stream or watercourse at the downstream toe of the dam.

The stability of the earth dam under various conditions which may exist following construction is a prime concern in the design of the slopes for the dam's earth embankment. It has been the experience of the District that 3:1 slopes for the upstream and downstream faces of the dam are usually stable even under the most adverse conditions. Steeper slopes may be approved by the District if their stability is demonstrated to be adequate when analyzed in accordance with accepted design criteria for small dams.

An area of approximately 1,200 square feet (30 x 40) should be provided at the top of the dam for a shelter house and parking adjacent thereto.

A-2.2 Foundation and Abutments

Preparatory to construction of the earth dam, the ground shall be stripped of all vegetation and other organic material. In addition, any trash, debris, soft or compressible material or other objectionable material unsuitable for support of the dam, whether disclosed by the subsurface investigation or discovered during stripping shall be excavated as directed by the soil engineer and approved by the responsible agency's inspector.

A-2.3 Percolation Path at Dam Contact Areas

The horizontal length of the path of percolation between embankment and abutments and foundation shall be of such length as to be consistent with limitations for percolation and piping based upon existing local soil conditions and type of embankment material to be used. The District has found that, as a general rule, a minimum path of percolation ratio of 8 to 1 is satisfactory (8 represents the level length of path along the contact and 1 represents the corresponding head differential between the elevation of upstream end of path and the maximum elevation of the basin water surface). This condition should be satisfied for any horizontal plane through the embankment above the contact of the bottom of the basin and upstream slope of embankment.

A-2.4 Crest of Dam

The crest of the dam shall be 20 feet wide (measured parallel to the center line of the spillway) and shall have a minimum rising slope from the spillway walls to the abutment equal to 60 per cent of the average grade of the natural stream bed, unless otherwise approved by the District. (See Figure 2, page I-7). It shall be graded to form a "V" shaped surface 6 inches deep at the center and paved with 3 inches

D. B. Man.

SECTION A Continued

of asphaltic concrete. A 4-inch diameter hole shall be provided in the spillway wall for drainage at the low point of the "V" shaped crest of dam.

A-2.5 Protection for Dam Slopes

A-2.5.1 Upstream Face

The upstream face of the earth dam shall be protected with a 6-inch thick (measured normal to slab) reinforced concrete facing slab unless otherwise approved by the District. The reinforcement for the concrete slab shall be No. 5 reinforcing bars at 18-inch centers in both directions placed in the center of the slab. The reinforcement shall be continuous through all construction joints and shall be spliced by lapping 20 bar diameters. Construction joints shall be parallel or at right angles to the center line of spillway and shall be spaced not more than 50 feet nor less than 10 feet apart. The slab shall be extended on the same slope to a depth of 5 feet below the bottom of the basin as well as to the bottom of the outlet works excavation. The slab shall also be extended into the abutments for a minimum of 2 feet. (See Figure 3, page I-8).

A-2.5.2 Downstream Face

The downstream face of the dam shall be protected from erosion by placing some type of protective covering such as planting or matting.

A-2.5.3 Slope Protection Gutter

"U" shaped gutters (Type B) shall be placed at the re-entrant contact of two planes of fill or the intersection of compacted fill and natural ground. (See Figure 1, page I-6).

A-3 Access to Dam and Basin

A 28-foot wide access road (two 12-foot lanes and 4-foot wide gutter) with adequate wearing surface, cross drains, and gutters shall be provided from the nearest public street into the basin area to permit removal and hauling of storm deposited debris. The access road shall be cross sloped towards the 4-foot wide gutter. The road grade downstream of the crest of dam shall not exceed 10 per cent; however, if such grade for some valid reason is not practicable, a grade of 15 per cent shall not be exceeded. Grades steeper than 10 per cent shall be paved with 3-inch A. C. The access ramp into the basin from the crest of dam shall be 20 feet wide on a grade not to exceed 10 per cent. No paving or gutter will be required for this portion of the access road.

D. B. Man.

SECTION A Continued

A-4 Access Road Gutter

The 4-foot wide drainage gutter for the access road shall be constructed of gunite, concrete, or A. C. The 4-foot wide gutter shall be so shaped as to be maintainable by use of mechanized equipment and be without a sharp drop so as to be safe and drivable for traveling vehicles. Details of an A. C. access road gutter are shown in Figure 1, page I-6.

A-5 Earthwork for Debris Dams and Basins

The earthwork for debris dams and basins shall be in accordance with Section 300-6 of the Standard Specifications for Public Works Construction, 1973 Edition.

A-6 Gage Board Pipe Supports

On the upstream side of dam on the same side as the access road, 2-1/2 inch diameter galvanized standard pipes shall be embedded in the facing slab for future installation of gage boards by the District. The pipes shall be 5 feet 6 inches long and project 4 feet 7 inches above the surface of the facing slab. They shall be placed in a straight line, usually parallel to the center line of the spillway, and so placed as to have a difference of 4 vertical feet between the pipes at the surface of the facing slab. The lowest pipe shall be set at an elevation one foot below the elevation of the bottom of the debris basin and the uppermost pipe at an elevation within 4 feet of the elevation of the crest of dam at the spillway wall. Details of a gage board pipe installation are shown in Figure 4, page I-9.

A-7 Debris Barrier

A-7.1 General

A debris barrier shall be provided upstream of the spillway to prevent large debris from entering and clogging the spillway and/or the conduit downstream of the spillway. This is usually achieved by placing a series of vertical members in the concrete facing slab so as to form a protective screen around the spillway entrance. A typical layout is shown on Figure 2, page I-7.

The debris barrier shall be designed considering the barrier to be 100 per cent plugged and acting as a submerged sharp crested weir. The freeboard between the crest of dam and basin water surface upstream of the debris barrier shall be a minimum of two feet.

SECTION A
Continued

A-7.2 Location and Spacing of Barrier

The debris barrier shall be placed upstream of the spillway and no closer than six feet from the intersection of the spillway invert slab and the concrete facing slab.

The top of the barrier members shall be placed one foot below the basin water surface elevation required to pass the design Q (burned and bulked) through the spillway.

The barrier members may be spaced up to four feet apart but in no case shall be more than two-thirds of the width of the conduit at the downstream end of the spillway.

A-7.3 Design of Barrier Member

The debris barrier shall be assumed to be 100 per cent plugged and the members designed for an equivalent fluid pressure of 62.5 psf. The loading can be considered as temporary and the allowable stresses increased by one-third.

The barrier member shall be assumed to be restrained laterally by the concrete facing slab and the embedment length shall be determined by use of the following formula developed by E. Czerniak:

$$L = 1.85 \sqrt[3]{\frac{M_o}{R}}$$

where:

L = Length embedment in feet

R = 300 psf/ft. depth (a constant)

$$M_o = \frac{M}{d}$$

M = Moment applied to barrier in foot pounds

d = Diameter of pipe encasement in feet

D. B. Man.

SECTION A
Continued

A-7.4 Selection of Barrier Member

The barrier member shall be selected so that the required section modulus is satisfied along the weak axis and may be of a structural steel shape, pipe, or square tubing. If a hollow member is selected, it shall be filled with concrete.

A-8 Right of Way

A-8.1 General

Sufficient right of way shall be provided for the construction and economical maintenance of the dam and basin and shall include sufficient area to provide for an access road from a dedicated public street to the basin.

A-8.2 Right of Way Limits

Right of way for the basin shall include the area encompassed by the contact points of the debris surface contours with the existing ground based on a theoretical debris slope, sloping upstream from the spillway crest, of 75 per cent of the average slope of the original stream bed for the total length of the basin site. In general, the contours of the theoretical debris surface shall be assumed as straight lines at right angles to the center line of the spillway and/or the basin and stream bed, depending on the shape of the basin involved.

The right of way for the access road from a dedicated street shall be wide enough to provide for a 28-foot wide road as described in Section A-3.

A-9 Fencing

Adequate fencing, enclosing the limits of the debris basin, shall be provided to discourage unauthorized persons from entering the area. Said fencing shall conform to District Standard Drawing No. 2-D 178 (see page I-29).

A-10 Debris Disposal Area

A debris disposal area, of sufficient storage capacity subject to District approval, shall be provided within an economical hauling distance from the debris basin.

SECTION B

SUBSURFACE INVESTIGATION REPORT

SECTION B
SUBSURFACE INVESTIGATION REPORT

B-1 Field Investigation

Prior to District approval of plans and specifications for a proposed debris basin, a subsurface investigation shall be made to obtain and present sufficient information about the soil, ground water, and foundation conditions on the project for the proper design of structures with minimum construction problems and low operation and maintenance costs. The subsurface investigation shall be planned and supervised by a registered civil engineer experienced in soil mechanics.

B-2 Subsurface Report

B-2.1 General

The original and one copy of the subsurface investigation report prepared by the soil engineer in accordance with the following requirements shall be furnished to the District at time of submittal of plans for the debris basin. The report shall contain findings and supporting information regarding the following items:

1. The types of materials to be encountered in the proposed excavations or borrow site.
2. Anticipated excavation problems.
3. Location and extent of required overexcavation.
4. Slope and excavation stability.
5. Bearing capacity and settlement characteristics of subgrade materials.
6. Suitability of excavated materials (including bedrock) for use as fill, backfill, and bedding.
7. Required relative compaction of fill and backfill materials.
8. Compaction characteristics of the predominant soil.
9. Substances in the ground water or in the native soils deleterious to concrete, steel, or other construction materials.

D. B. Man.

SECTION B
Continued

B-2.2 Detailed Recommendations

Specific, detailed recommendations with supporting data shall be included for such items as, but not limited to, stability of cut slopes; excavation in bedrock; necessary depth of stripping or overexcavation in areas to be covered by fills to minimize settlement; subdrains or toe drains and the gradation requirements for required filter and drain materials; stability of proposed dam embankment under the various conditions that may exist following construction, with due allowance for seismic loading and seepage; inlet structures as needed to prevent unacceptable erosion of stream bed material upstream of the basin; stability of natural slopes; erosion prevention treatments, including plants, drainage devices, or erosion resistant covers for cut and fill slopes, including the downstream face of the dam, and for the crest of the dam.

Field observations of items which can affect the construction operations, such as surface water flow, springs and seeps, bedrock outcroppings, trash dumps, existing wells or tunnels, large concrete blocks, etc., shall be recorded in the report.

All field, laboratory, and office information shall be submitted on 8-1/2" x 11" sheets or on sheets folded to that size.

B-3 Exploratory Borings

B-3.1 Location and Number of Borings

Borings shall be drilled at least at the following locations:

1. Proposed dam foundation.
2. Each dam abutment.
3. Along alignment of outlet pipe.
4. Borrow area.
5. Proposed inlet structure and outlet tower, etc.
6. Proposed cut slopes for access road and basin.

A boring may be located to furnish information for more than one of the areas listed above. On the other hand, it may be necessary to drill borings at locations not listed above but which are necessary to provide complete subsurface information.

D. B. Man.

SECTION B
Continued

It may be possible to reduce the number of borings needed by the use of supplemental information obtained by seismic or electrical resistivity methods. However, it will not be permissible to replace the drilling of borings entirely with geophysical methods.

B-3.2 Depth of Borings

The minimum boring depth shall be as follows unless firm bedrock is encountered at shallower depths:

1. Borings in the foundation of the proposed dam shall be drilled to firm material, bedrock, or to a minimum depth equal to the height of the dam at the crest. If soft or loose materials are found at this depth, drilling shall be continued until firm material is reached.
2. Borings at the abutments shall extend to firm material suitable for support of the dam.
3. Borings in borrow areas or in proposed cut slope areas shall extend at least five feet below the proposed excavation line.
4. Borings at locations for structures shall extend at least five feet below structure subgrade. If water is encountered, the boring shall be drilled at least ten feet below structure subgrade.

B-3.3 Type of Borings

The word "boring" as used herein shall include borings by drill rigs, holes, pits, or tunnels dug by hand-held equipment or by equipment such as bulldozer, backhoe, or clam bucket.

Borings shall be drilled dry, if possible, by using buckets, augers, or similar tools to facilitate examining, sampling, and logging the materials as encountered. The use of drilling mud should be avoided if casing can be used. Continuous flight helical augers may be used only as the last resort to drilling where other methods have failed.

D. B. Man.

SECTION B
Continued

B-4 Logs of Borings and Location Map

B-4.1 General

The logs of borings shall include Unified Soil Classification System descriptions and group symbols as shown in District Drawing No. 2-D 413 (see page I-31) and shall include pertinent notes about water elevations, seepage, approximate per cent rock encountered, ease of drilling, type and depth of soil or rock sample, caving, running sands, trash, and any other useful information. Pertinent information as indicated in Column 6 on Drawing No. 2-D 413 shall be included. Descriptions and group symbols shall be consistent with results of laboratory classification tests. The elevation of proposed excavation subgrade, etc., shall be shown graphically on the log. Exploratory borings shall be identified with a numbering sequence increasing upstream.

The boring locations shall be shown on a recent topographic map to a scale not less than 1" = 100'. Boring locations may be referenced in terms of coordinates if such a system is available or by offsets and the stationing along the center line of the basin or spillway. The elevation of the ground surface at each boring location, the date each boring was drilled, and method of drilling shall be included.

B-4.2 Ground Water

The logs of borings shall indicate the depth at which ground water was encountered. Any change in the ground water level during drilling shall be noted. If water was not encountered, a statement to that effect shall be included.

B-5 Samples

Samples representing each type of material encountered shall be obtained in each boring. Both undisturbed and bulk soil samples of each type of material shall be obtained if reasonably possible. In cases where all or most of the soil in a boring is of one type, there shall be no less than two representative undisturbed and bulk soil samples taken from each boring. When very firm soil or a large rock mass (not boulders) is encountered within the proposed excavation for a structure or cut which cannot be penetrated by normal soil boring equipment, core samples shall be obtained.

D. B. Man.

SECTION B
Continued

Samples of any ground water encountered shall be obtained for chemical analysis. Samples of any surface water flowing at the site shall also be obtained.

Soil and bedrock samples shall not be discarded until after notification to the District's Materials Engineering Division either in writing or by telephone at 226-4285. District personnel may elect to examine the samples and possibly store them on District premises.

B-6 Laboratory Analyses

B-6.1 Required Analyses

Laboratory analyses shall be made on the soil samples as indicated in the following table:

(See next page for table)

D. B. Man.

LABORATORY ANALYSES

Purpose

Method

Type

Mechanical Analysis (See Note 2)	ASTM D 422	Evaluation of project excavation material for use as fill, backfill or bedding.
Sand Equivalent Determination	ASTM D 2419 or California Test Method No. 217	
Laboratory Maximum Density (See Note 3)	California Test Method No. 216	Establishing the in-place soil density and relative compaction of major soil types. (See Note 4)
Density of Soil in Place	ASTM D 2937, D 2167, D 1556	
Moisture Determination	ASTM D 2216	
Strength Characteristics (See Note 5)	Triaxial Shear Test Direct Shear Test	Evaluation of bearing values; embankment and slope stability; and tunnel loads.
Consolidation Characteristics (See Note 6)	ASTM D 2435	Evaluation of the degree of compression, collapse, or expansion of soils.
Chemical Analysis (See Note 7)	Analysis of a distilled water soil extract, ground water, or surface water in accordance with: ASTM D 516 - Sulfate; ASTM D 1067 - Acidity; ASTM D 512 - Chloride.	Determination of the presence of sulfates, acids and chlorides in ground water or in the native soil (as per cent dry weight of soil) which are deleterious to concrete, steel, or other construction materials.

SECTION B
Continued

B-6.2 Notes Pertaining to Laboratory Analyses

The following shall apply to the performance of the analyses:

1. All necessary laboratory tests shall be performed by a laboratory certified by the City of Los Angeles, Department of Building and Safety, or by the Department of County Engineer, or by a laboratory operated by the public agency having jurisdiction.
2. The mechanical analysis shall be performed on representative portions of bulk samples using sieve sizes 3", 3/4", #3/8, #4, #8, #16, #30, #50, #100, and #200. Other combinations of sieves may be used as allowed by the ASTM procedure. At least one mechanical analysis test shall be made for each major soil type encountered. The analysis of predominant non-plastic soil types shall be repeated in alternate borings. Gradation curves shall be furnished for the soils which contain less than 12 per cent passing the No. 200 sieve.
3. A sufficient number of laboratory maximum density tests shall be performed to be used by the consultant to calculate the relative compaction of each undisturbed soil sample. A laboratory maximum density test result may be used to calculate the relative compaction of similar soils from other nearby borings. However, a laboratory maximum density test result shall not be applied to a density test farther than 500 feet from the boring where the material for the laboratory maximum density was taken.
4. Relative compaction means the ratio of the field dry density to the laboratory maximum density expressed as a percentage.
5. Triaxial shear test values shall be reported in terms of both total and effective stress. Direct shear test values shall be reported in terms of both peak and ultimate shear strength.
6. Sample to be submerged in water during the test.
7. One determination in each boring where ground water was encountered and one determination per alternate boring where ground water was not encountered.

D. B. Man.



SECTION C

ENGINEERING GEOLOGY
INVESTIGATION REPORT



SECTION C

ENGINEERING GEOLOGY INVESTIGATION REPORT

C-1 Field Investigation

In addition to the subsurface investigation described in Section B, Sub-section B-1, sufficient surface and subsurface engineering geological exploration shall be made to permit the District to make an adequate assessment of geological problems which may be encountered during project construction.

C-2 Geologic Report

C-2.1 General

The original and one copy of the engineering geology investigation report prepared or supervised by a registered geologist certified in engineering geology, in accordance with the following requirements, shall be furnished to the District at the same time as the subsurface investigation report described in Section B.

The report shall be accompanied by an independently prepared geological map, prepared on a topographic base map of sufficient scale to show detail, yet not overly limited so as not to show important geologic features in close proximity to the project. A sufficient number of geologic cross sections should be submitted with the map to show correlation of all subsurface data, from test borings and other sources, with surface data.

The location of all subsurface data shall be indicated in the text of the report as well as on all maps and cross sections. In addition, a copy of the geologic logs for each test boring or other sources of subsurface data shall be included in the text, or appended thereto.

Geologic logs of borings shall contain a lithologic description of the geologic character of each stratum, the depths at which changes in the character of materials are observed, the thickness of the strata, and depth to water (where applicable).

The engineering geology report shall, in the text, contain findings and supporting information for, but not limited to, the following:

1. Type and extent of in situ rock and/or unconsolidated surficial deposits to be encountered.
2. Structural features.

D. B. Man.

SECTION C
Continued

3. Surface water and ground water conditions.
4. Other geologic features of special significance to the project.
5. Excavation problems related to bedrock.
6. Location of fill.
7. Needs for additional subsurface data.
8. Special construction problems.

The scope, length, and organization of reports will be highly dependent upon the physical situation of the project and the following comments are intended to serve as a general guide and check list for those who prepare and use geological reports, rather than a rigid framework of requirements.

C-2.2 Detailed Information

In accordance with the above noted general requirements, the following is a detailed, though not necessarily complete, list of topics that ordinarily should be considered in geologic reports submitted to the District:

1. In Situ Rock and Surficial Deposits
 - a. Identification, distribution, and general physical characteristics.
 - b. Special physical characteristics or chemical features, distribution of weathered zones, and significant differences between fresh and weathered material.
 - c. Response to natural surface and near surface processes (e. g. mass movement, ravelling, gullyng, etc.).
2. Structural Features (e. g. faults, shears, folds, joints, foliation, schistosity)
 - a. Occurrence, distribution, and effects upon the in situ rock and other earth materials.
 - b. Special features of faults (e. g. zones of gouge and breccia, nature of offsets, active or inactive).
 - c. Seismicity consideration (e. g. earthquake activity, historical recordings, anticipated forces, etc.).

D. B. Man.

SECTION C
Continued

3. Surface and Ground Water Conditions

- a. Distribution and occurrence (e. g. streams, ponds, swamps, springs, seeps, subsurface basins).
- b. Relation to topography and geologic features (e. g. pervious strata, faults, fractures).
- c. Effect of water on the properties of in situ materials.
- d. Water rights, existing rights, potential effects of proposed construction on ground water regimen.

4. Geologic Features of Special Significance

- a. Slump and slide masses within the drainage areas in surficial deposits and in situ rock, including distribution, geometric characteristics, correlation with topographic and geologic features, age and rates of movement, etc.
- b. Indications of subsidence or settlement (e. g. scarplets, fissures, crack patterns, topographic bulges, tilted reference features, historic records and measurements).
- c. Features indicative of accelerated erosion (e. g. cliff re-entrants, badlands, advancing gully heads).

5. Excavation Problems

- a. Prediction of what materials and structural features will be encountered.
- b. Prediction of cut slope stability.
- c. Rippability estimates for unusually hard or massive rock (e. g. classification as to rippable, marginally rippable and non-rippable based on average seismic velocity of materials).
- d. Recommendations for reorientation or repositioning of cuts, reduction of cut slopes, development of compound cut slopes, special stripping above daylight lines, buttressing, protection against erosion, handling of seepage water, setbacks for structures above cuts, etc.
- e. Excessive ground water flows.
- f. Problems caused by features or conditions in adjacent properties.

D. B. Man.

SECTION C
Continued

6. Location of Fill

Recommendations for positioning of fill masses, special preparation of ground to be loaded with fill, provision for underdrainage, buttressing, special protection against erosion, setbacks for structures near edges of fill prisms, etc.

7. Recommendations for Additional Subsurface Testing, Exploration and Inspection

- a. Cuts and test holes needed for additional geologic information.
- b. Program of subsurface exploration and testing, based upon geologic considerations, that is most likely to provide data needed by the foundation engineer.
- c. Geologic inspection needed during construction.

8. Special Construction Problems

- a. Areas to be left as natural ground.
- b. Removal or buttressing of existing slide masses.
- c. Problems of ground water circulation.
- d. Position of structures with respect to active faults.



SECTION D

STRUCTURAL DESIGN CRITERIA



SECTION D
STRUCTURAL DESIGN CRITERIA

D-1 General

The minimum and maximum reinforcing bar size for cast-in-place conduits shall be #4 and #9, respectively. The clear distance between parallel bars shall not be less than the nominal bar diameter, 1-1/2 times the maximum size coarse aggregate, or 1 inch. The main stress-carrying steel shall be centered not farther apart than 3 times the member thickness nor more than 18 inches. Where conduit is constructed on curves, steel shall be placed radially from the maximum spacing and special attention shall be given to steel details to insure that the spacing on the inside of curves is not less than the allowable.

Main stress-carrying steel shall comply with A. S. T. M. A-615, Grade 60. Longitudinal steel shall comply with either A. S. T. M. A-615, Grade 40 or Grade 60. Anchorage requirements for reinforcing steel shall be as specified in Section 918 of ACI 318-63. Splices for stress-carrying steel shall be 30 bar diameters minimum and for longitudinal steel 20 bar diameters. Shear stress shall be calculated in accordance with Section 1201 of ACI 318-63.

The 28-day compressive strength of the concrete shall be specified to be 4000 psi for spillway walls and 5000 psi for the invert slab. However, in design, both the spillway walls and the invert slab shall be designed on the basis of 4000 psi concrete. The concrete for structures other than the spillway may have a 28-day compressive strength of 3000 psi. However, the concrete for the "U" shaped gutters for slope protection may have a 28-day compressive strength concrete of 2000 psi.

Design criteria not specifically covered in this manual shall be as specified in the 1963 Edition of the "Building Code Requirements for Reinforced Concrete" (ACI 318-63) published by the American Concrete Institute.

Design of conduits which join the spillway and conveys the flows from the spillway and basin shall be designed in accordance with the District's "Structural Design Manual".

Design of structural steel members shall be in accordance with the current edition of the A. I. S. C. Manual of Steel Construction. Allowable stresses for members subjected to temporary loadings, such as debris barriers, may be increased by one-third.

D. B. Man.

SECTION D
Continued

D-2 Allowable Stresses

Allowable concrete and reinforcing steel unit stresses shall be as shown below.

Concrete	Maximum Stress	Any Strength Concrete	Stress for f'_c equal to	
			3000 psi	4000 psi
<u>Flexure, f_c</u>				
Extreme fiber in compression		.45 f'_c	1350 psi	1800 psi
Extreme fiber in tension, in plain concrete		$1.62\sqrt{f'_c}$	88	102
Extreme fiber in tension, in reinforced concrete		None		
<u>Shear, v</u>				
Beams without web reinforcing		$1.1\sqrt{f'_c}$	60	70
Horizontal shear in shear keys		.10 f'_c	300	400
<u>Bond, u</u>				
Top bars*	350 psi	$3.4\sqrt{f'_c/D}$	186/D	215/D
All others	500	$4.8\sqrt{f'_c/D}$	263/D	304/D
<u>Bearing, f_c</u>				
On full area			750 psi	1000 psi
On 1/3 area or less			1125 psi	1500 psi

*Top bars are horizontal bars having more than 12 inches of concrete cast in the member below the bar.

D. B. Man.

SECTION D
Continued

Reinforcing SteelUnit Stresses

Tension

Flexural members and web reinforcing

24,000 psi

Compression

Combined flexure and axial stress

nfc

Compression, flexural members

n times the compression
in the surrounding
concrete



SECTION E

DESIGN OF
RECTANGULAR SPILLWAY



SECTION EDESIGN OF RECTANGULAR SPILLWAYE-1 Hydraulic DesignE-1.1 Spillway Design Q's

The District will provide assistance in the determination and/or confirmation of design Q's upon request provided a suitable drainage map of the area is submitted. It is recommended that confirmation of design Q's be obtained from the District prior to start of design.

E-1.2 Spillway Requirements

The width of spillway and height of spillway walls at the crest shall be determined by use of the broad crested weir formula with the coefficient of discharge $C = 2.80$. The spillway shall be sized to pass the District's capital flood Q with an allowance made for increased flow due to a burned watershed and the inclusion of bulking of the flow caused by inorganic debris with the appropriate freeboard or the greater of "Creager's Q" (see page I-11) or the probable maximum precipitation (PMP) Q with zero freeboard whichever requires the higher walls. Downstream of the crest, the spillway walls shall contain the above mentioned flows with their respective freeboards as far downstream as the toe of dam embankment. The height of spillway walls shall not be less than 6 feet and the convergence of the walls shall not exceed 5 degrees for each side of the spillway or 10 degrees for total convergence. The floor of the spillway upstream of the crest shall slope down at a 3 per cent grade toward the basin for drainage.

E-1.3 Freeboard

The minimum freeboard at spillway crest shall be 2 feet or equal to 25 per cent of head differential from the spillway crest to the water surface in the basin, whichever is greater.

Downstream of the crest, the minimum freeboard shall be 2 feet for average flow velocities of 35 fps or less and 3 feet for average flow velocities greater than 35 fps.

E-2 Structural DesignE-2.1 Method of Design

Consideration shall be given in each individual project to the conditions of soil, ground water level, slope of adjacent ground surface and live loading, existing or proposed.

D. B. Man.

SECTION E
Continued

The design of the spillway structure shall consider seismic forces and provide for active earth load pressures as calculated by the Coulomb theory plus additional pressures resulting from application of horizontal and vertical accelerations to the sliding wedge.

Two analyses shall be made of each section, empty and flowing full. The spillway structure shall be considered as a "U" channel and be designed as a rigid frame.

E-2.2 Horizontal Loads

E-2.2.1 Spillway Empty

Spillway walls, regardless of height, shall be designed for a lateral soil force applied on the earth face of the wall equivalent to:

$$P = 1/2 wH^2 [K + 3/4 (a/g)]$$

where:

P = Total lateral force, pounds per lateral foot of spillway wall

w = Soil density, pounds per cubic foot

H = Wall height, feet

K = Coefficient of active earth pressure, abstract number

a = Horizontal ground acceleration, feet per second per second

g = Acceleration due to gravity, feet per second per second

The active soil pressure represented by $1/2 KwH^2$ shall be applied at a point $1/3 H$ above the base and the dynamic force represented by $3/8 (a/g) wH^2$ shall be applied at a point $2/3H$ above the base. It is recommended that a value of $1/3$ the acceleration due to gravity be used for the horizontal ground acceleration. Curves showing moments and shear for the above loading (earth plus dynamic) are shown on page I-12.

Where existing, the effect of a sloping surcharge on the lateral soil force shall be taken into consideration. It may be advisable to increase the width of berm adjacent to the spillway wall to prevent excessive earth loads due to sloping surcharge.

D. B. Man.

SECTION E

Continued

E-2.2.2 Spillway Full

Spillway walls, regardless of height, shall be designed for 40 psf equivalent fluid pressure applied on the water side to top of wall. This assumes active resistance from the soil outside the walls, or allows an increase in stresses for short time loading should active pressure not exist. Moment and shear curves for 40 psf equivalent fluid pressure are shown on page I-12.

E-2.2.3 Stability and Sliding

Rigid frame "U" channels with differential lateral loadings shall be checked for stability, soil reaction, and sliding. The factor of safety against sliding shall be 1.5 minimum.

E-2.3 Vertical Loads

The weight of earth shall be assumed at 110 pcf, the weight of water at 62.5 pcf and the weight of concrete at 150 pcf.

E-2.4 Soil Pressure

Soil pressures on "U" channels shall be computed considering the invert slab as a beam on an elastic foundation (see "Beams on Elastic Foundations" by M. Hetenyi, University of Michigan Press, Ann Arbor, Michigan, 1946). Design information and curves showing moments and soil pressures in "U" channels are included herein, pages I-13 through I-28. When the width of channel is less than the minimum values shown on the curves, uniform soil pressure shall be assumed.

E-2.5 Construction Joints

E-2.5.1 General

Construction joint details shall be shown on the project drawings.

E-2.5.2 Transverse Construction Joints

Transverse construction joints shall not be more than 50 feet or less than 10 feet apart and construction joints in the walls and slabs shall be in the same plane. Shear keys shall not be used for transverse construction joints and steel reinforcement shall be continuous through the construction joints and lapped 20 bar diameters.

D. B. Man.

SECTION E
Continued

Concrete anchors as shown on Figure 2, page I-7, shall be constructed monolithically with the transverse invert slab joints. The anchors shall be placed within the limits of the spillway that lies on the downstream slope of the dam.

E-2.5.3 Longitudinal Construction Joints

Shear keys shall be used in longitudinal wall joints which shall be located at an optional 4 inches to 12 inches above the invert slab.

E-2.6 Thickness of Members

Side walls shall have a minimum thickness of 8 inches. The earth face of walls shall be battered from the required thickness at the base to the minimum thickness at the top.

Invert slabs shall have a minimum thickness of 9 inches. There shall be a minimum projection of the invert slab beyond the walls (i. e. a heel) of 6 inches.

E-2.7 Placement of Steel Reinforcement

E-2.7.1 Steel Clearances

Steel clearances should be shown on the project drawings from the center of the bar to the face of the concrete. Said clearances shall not be less than the following distances:

Side walls, inside and outside - 2 inches

Top of invert slab - 2-1/2 inches for velocities less than 10 feet per sec.

3 inches for velocities of 10 feet per sec. or more but less than 40 feet per sec.

3-1/2 inches for velocities of 40 feet per sec. or more.

Bottom of invert slab - 2-1/2 inches.

Where concrete is subject to the action of harmful ground water, soils, etc., an additional cover of 1/2 inch shall be provided.

D. B. Man.

SECTION E
Continued

E-2.7.2 Transverse Reinforcement

Transverse reinforcing steel shall be as follows:

1. Minimum size of reinforcing bars shall be #4 and the maximum spacing 18 inches.
2. Earth face wall steel shall be "L" bars bent into the bottom face of the invert slab.
3. Channel face wall steel shall be "L" bars bent into the bottom face of the heel.
4. "U" bars shall not be used.
5. Unduly long bars shall be avoided.

E-2.7.3 Longitudinal Reinforcement

Longitudinal reinforcing steel shall be #5 bars at 12-inch centers in each face of walls and slabs and shall be continuous through the construction joints.

E-3 Subdrains

A subdrainage system shall be provided for the spillway structure and shall be designed to discharge through the spillway walls at a minimum height of 18 inches above the invert slab. The subdrains shall consist of 6-inch perforated pipes laid in trenches filled with drain material. See Figure 5, page I-10, for details.

Not more than three lateral subdrains shall be connected to a longitudinal subdrain which conveys the waters from the laterals and discharges the flow through the spillway wall. The portion of the longitudinal subdrain between its discharge end and the closest lateral connected to it shall be of non-perforated pipe.

D. B. Man.

SECTION F

OUTLET WORKS

SECTION F
OUTLET WORKS

F-1 General

The outlet works consist of an outlet tower, base, and an encased outlet pipe which extends under the dam from the outlet tower and usually outlets into and is joined to the spillway with a junction structure. Hydraulically, the system shall be designed for non-pressure flow at maximum head with a discharge of 150 cfs. The flow shall be regulated by the size of the opening at the base of the tower. The slope of the outlet pipe shall not be less than 5 per cent in order to maintain the system free of silt deposits, unless otherwise approved by the District.

F-2 Outlet Tower

The tower shall be a reinforced concrete structure which may be constructed by either pouring the concrete in place or by guniting. Unless otherwise approved by the District, the requirements for the tower shall be as follows:

1. The inside diameter shall be 5 feet and the wall thickness shall be 6 inches.
2. The openings in the wall of the tower shall be rectangular in shape, 24 inches long and 4 inches wide on the outside face and tapered to 5 inches wide on the inside face. Eighteen openings shall be equally spaced around the circumference.
3. The height of the tower shall be determined by locating it at the lowest point of the debris basin and constructing it to a height that shall project at least 1 foot above the theoretical debris slope.
4. The tower shall be located so that it is away from the direct line of flow between the inlet to the basin and the spillway.
5. The tower shall have safety collars set 9 feet apart vertically and a removable cover with an access manhole set on top of the tower for maintenance purposes.
6. A smooth transition to the outlet pipe shall be provided in the base of the tower.

Details of the outlet tower and steel reinforcement are shown on Drawing No. 2-D 404, page I-30.

D. B. Man.

SECTION F
Continued

F-3 Outlet Pipe

The reinforced concrete outlet pipe shall not be less than 36 inches in diameter, encased in concrete, sufficiently reinforced to prevent cracks, and be provided with cutoff collars to prevent piping along the pipe encasement. The length of the encasement shall be from the outlet tower base to the junction with the spillway wall. In cases where the junction with the spillway wall is downstream of the toe of the dam fill, the 36-inch reinforced concrete pipe is not required to be encased between the downstream toe of the dam fill and the junction structure at the spillway wall. Details of the outlet pipe, encasement, and steel reinforcement are shown on Drawing No. 2-D 404, page I-30.

The subgrade for the outlet pipe encasement or outlet pipe shall be over-excavated by 2 feet 6 inches unless the subgrade is on bedrock. In cases where it can be shown to the satisfaction of the District that the subgrade is on bedrock, the subgrade shall be at the bottom of the concrete encasement. The details as shown on Drawing No. 2-D 404 shall be revised accordingly.

D. B. Man.



SECTION G

S P E C I F I C A T I O N S



SECTION G
SPECIFICATIONS

Specifications covering the work to be performed shall either be set forth in the construction plans or submitted separately in typed form.

The specifications shall adequately describe the requirements for clearing, grubbing, stripping, excavating, placing fill and backfill, relative compaction requirements, methods of testing, disposal of excess and removed material, and all other related earthwork operations. Said specifications shall be based upon the information obtained from the subsurface investigation report and the engineering geology investigation report covered under Sections B and C.

The specifications shall also require the submittal of a signed construction report by the geologist and soil engineer covering observations made during the excavation for the dam foundation and abutments as described in Section H, Subsection H-2.

In addition, the specifications shall describe the requirements for materials and construction requirements involving concrete, pipe subdrains, reinforced concrete pipe, gunite, and all other items to be incorporated in the project.

The specifications may incorporate applicable portions of the "Standard Specifications for Public Works Construction", 1973 Edition, including Supplements thereto as well as the District's Additions and Amendments and Additional Provisions thereto (Parts D through M) by means of appropriate reference thereto. In this respect, particular attention is directed to Subsection 300-6 and to Subsection 303-1 of said specifications.

D. B. Man.



SECTION H

CONSTRUCTION REQUIREMENTS



SECTION H
CONSTRUCTION REQUIREMENTS

H-1 General

The construction of debris dams and basins shall be strictly in accordance with plans and specifications approved by the District. All earthwork construction, including stripping, excavation, overexcavation, backfill, and fill shall be supervised by the same soil engineer who performed the subsurface investigation, unless District approval to the contrary is obtained in advance. The soil engineer shall perform or supervise the necessary soil tests and shall direct the earthwork operations to assure conformance with the approved plans and specifications. Results of all tests shall be submitted to the District. All inspection and testing shall be without cost to the District and the District reserves the right to make its own inspections and tests, and to be compensated for the expense of such inspection and tests by the owner or the contractor.

H-2 Construction Reports

During construction, in the stripping and excavation phase, the soil engineer and the geologist shall observe and compile data on the actual depth of stripping and materials encountered in the excavation for the foundation and abutments of the dam and prepare a construction report on the actual conditions encountered in the field. The report shall also include a geologic map showing the location and various types of material exposed in the dam foundation and abutment areas. The geologic map shall be prepared from a topographic survey made to the same scale as the contract drawings. Both the report and the geologic map shall be signed by the soil engineer and the geologist and submitted to the District within 30 days after completion of the excavation for the dam foundation and abutments.

After completion of construction, the soil engineer shall prepare and sign a brief final construction report and submit it to the District with the "as built" drawings described in Section H-4. The final construction report shall include results of all tests with complete information and identification as to date, location, and elevation. It shall document field observations made of the actual construction of the dam and basin including any changes made to the contract drawings.

H-3 Supplemental Information and Recommendations

If it should prove necessary to make changes in the design or construction which may affect the operation or maintenance of the basin, supplemental information and recommendations shall be submitted. For example, if an unexpected shortage of borrow material should require the use of a new borrow area or pit, the materials in the new source shall be investigated by the soil engineer and approved by the District prior to use.

D. B. Man.

SECTION H
Continued'

H-4 "As Built" Drawings

After completion of construction, a set of "as built" drawings showing all changes to the contract drawings which were made during construction shall be submitted to the District. Each sheet of the contract drawings shall have "AS BUILT" noted in the lower right hand corner whether or not that particular sheet had any "as built" changes made on it.

D. B. Man.

See Page I-3

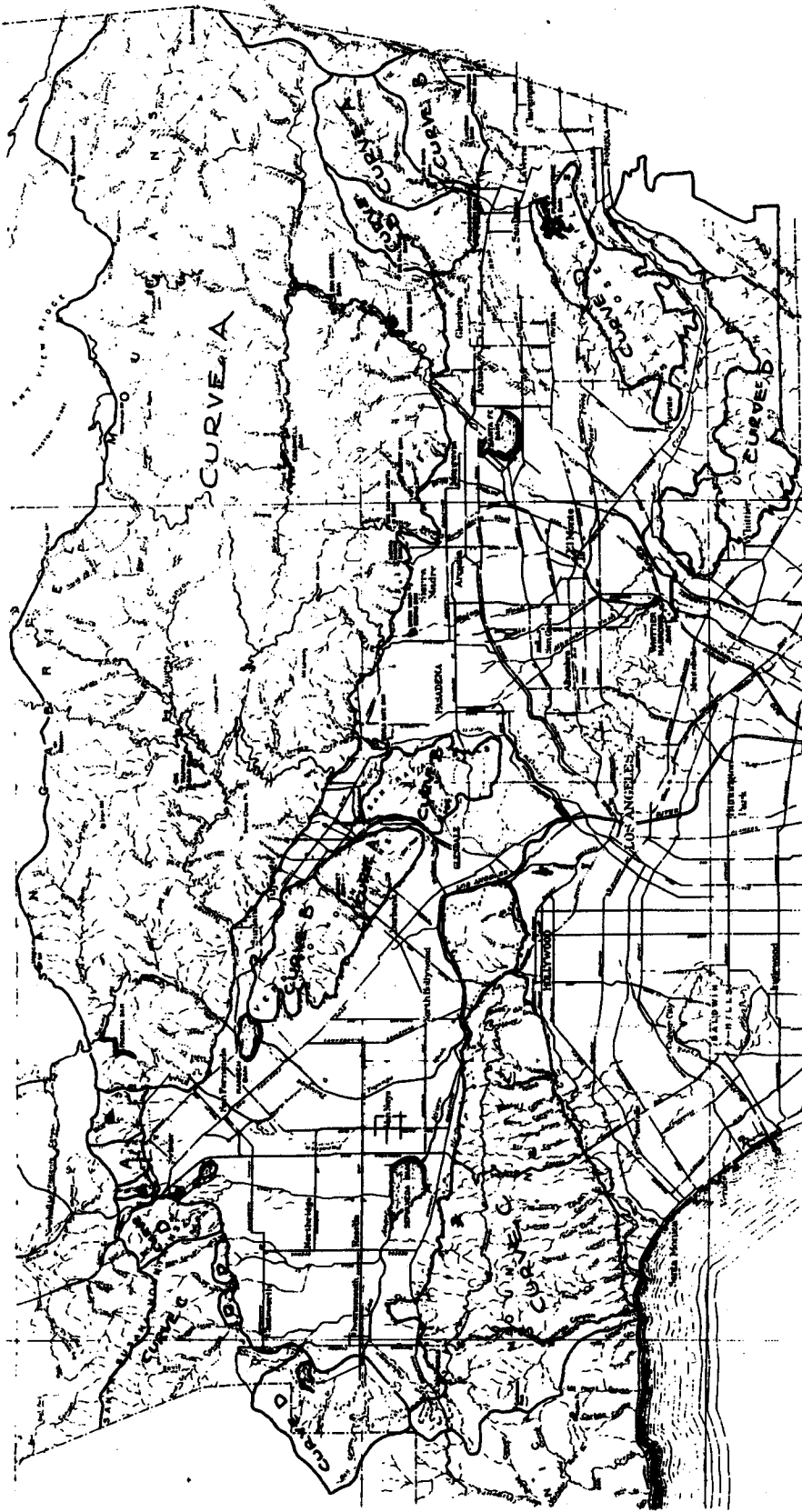

See Page

DEBRIS PRODUCTION ZONES
 See Page I-4 for Debris
 Production Curves

MOMENTS IN INVERT SLAB OF RECTANGULAR SPILLWAYS 16 FT. HIGH WALLS

CASE II

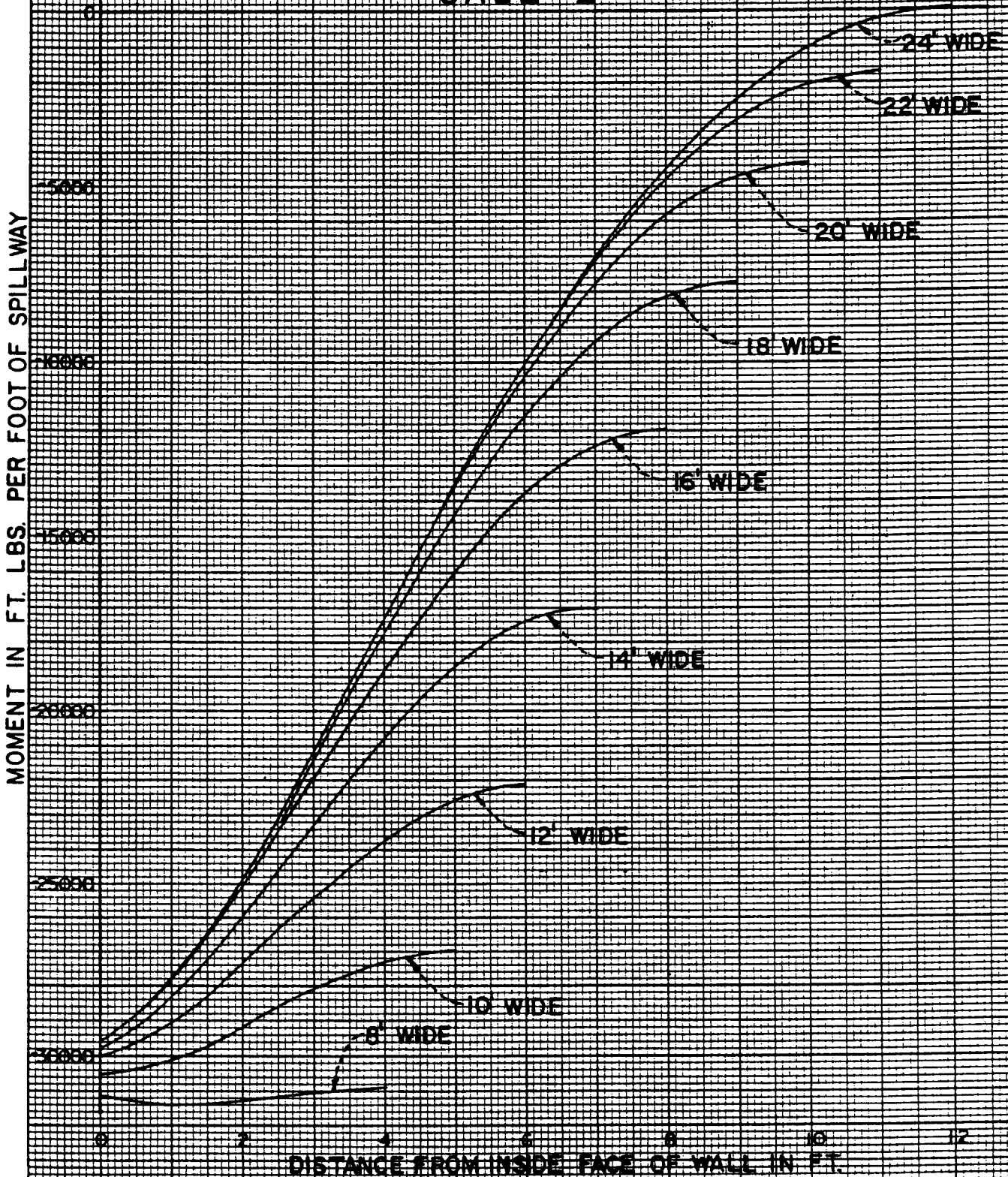

SOIL PRESSURES ON INVERT SLAB OF RECTANGULAR SPILLWAYS 6 FT HIGH WALLS

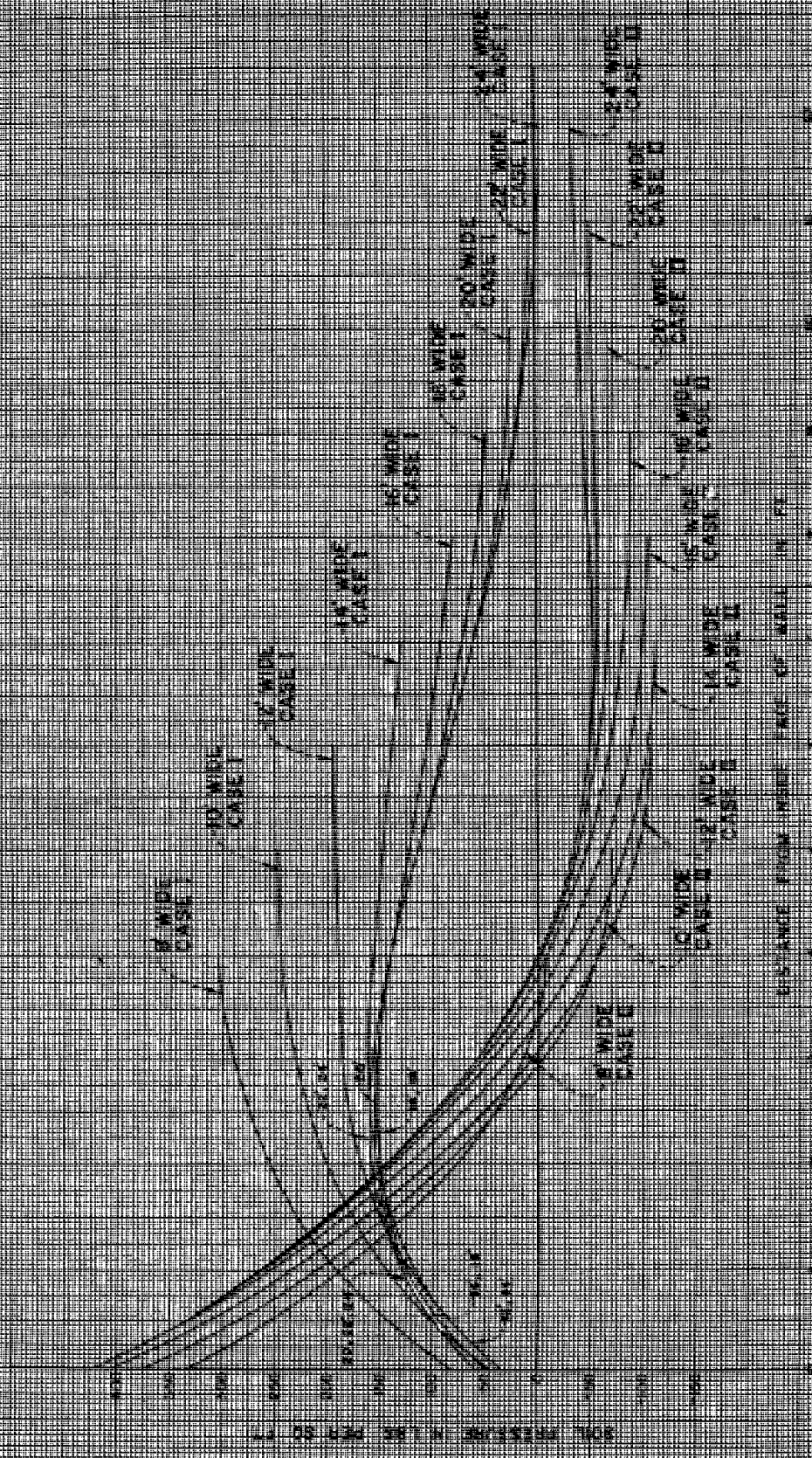

D. B. Mann

SOIL PRESSURES ON INVERT SLAB OF RECTANGULAR AIR SPILLWAYS WITH HIGH WALLS

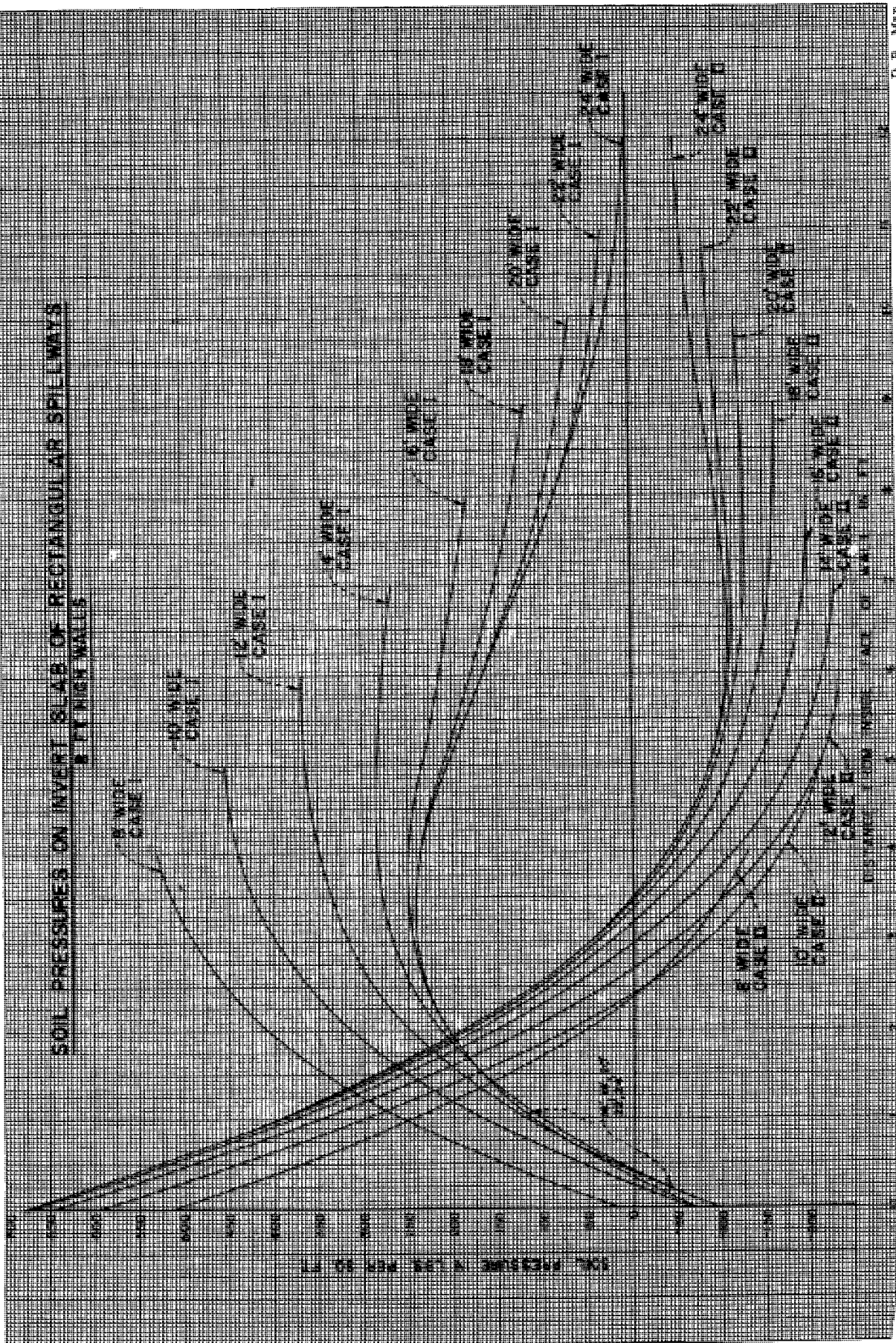

SOIL PRESSURES ON INVERT SLAB OF RECTANGULAR SPILLWAYS

10 FT HIGH WALLS

8 WIDE CASE I

12 WIDE CASE I

14 WIDE CASE I

16 WIDE CASE I

18 WIDE CASE I

20 WIDE CASE I

22 WIDE CASE I

24 WIDE CASE I

26 WIDE CASE I

28 WIDE CASE I

30 WIDE CASE I

32 WIDE CASE II

34 WIDE CASE II

36 WIDE CASE II

38 WIDE CASE II

40 WIDE CASE II

42 WIDE CASE II

44 WIDE CASE II

46 WIDE CASE II

48 WIDE CASE II

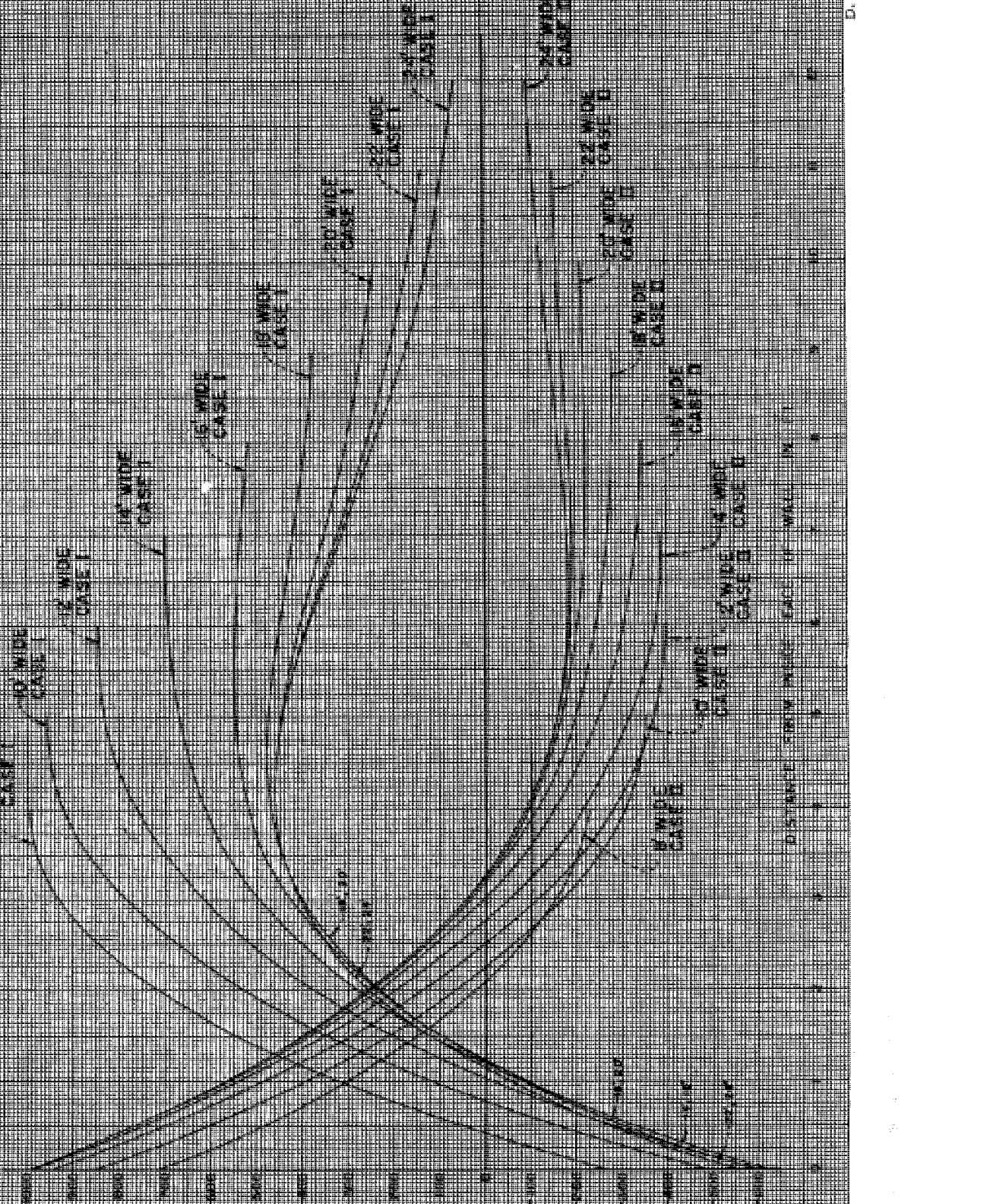

SOIL PRESSURES ON INVERT SLAB OF RECTANGULAR SPILLWAYS

2 FT HIGH WALLS

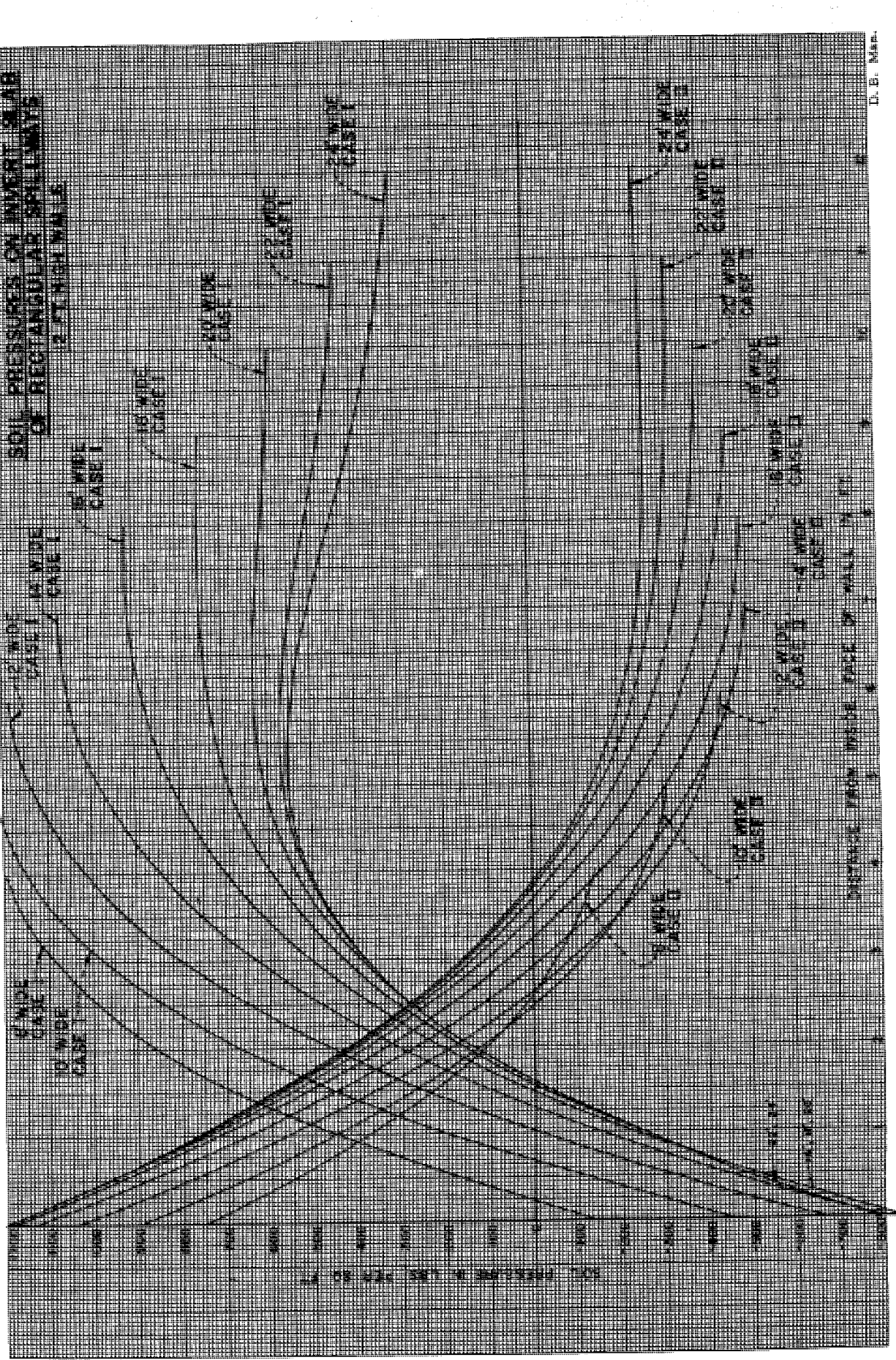

SOIL PRESSURES ON INVERT SLAB OF RECTANGULAR SPILLWAYS 10 FEET HIGH WALL

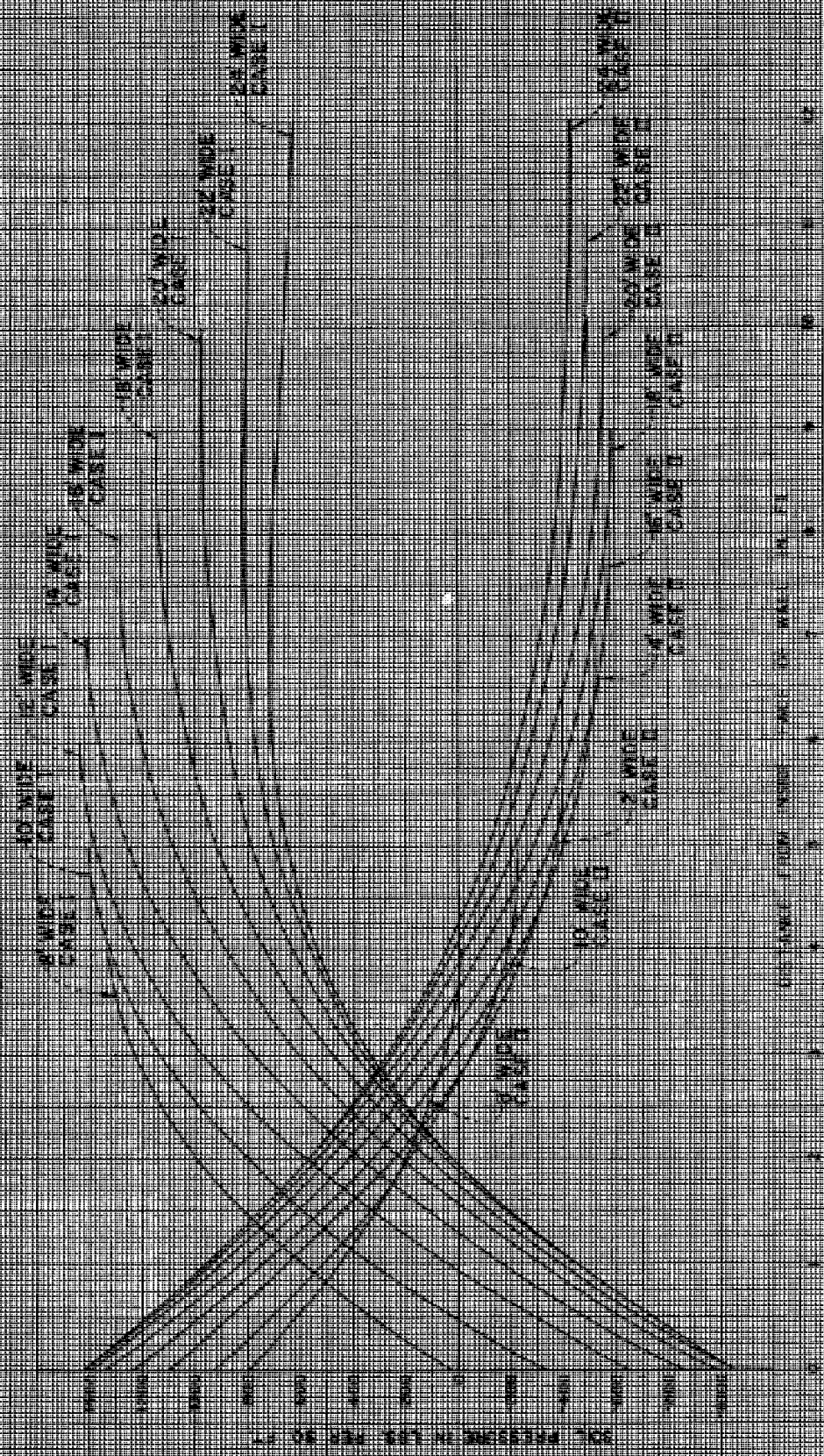

D. E. Mack

SOIL PRESSURES ON INVERT SLAB OF RECTANGULAR SPILLWAYS OF 7' HIGH WALL

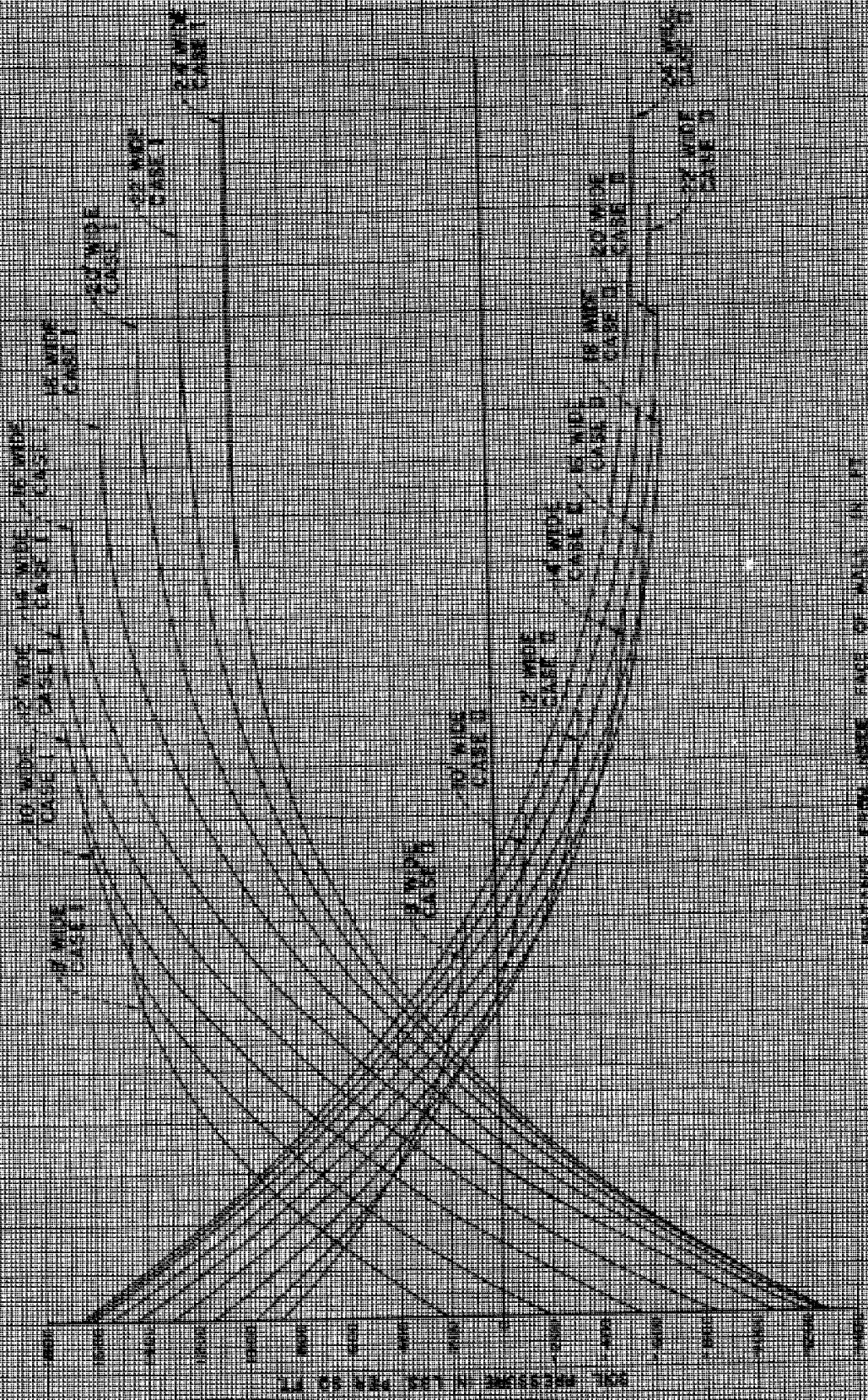

GENERAL NOTES

1. All chain line fence materials and fittings shall conform to Standard Specifications for Public Works Construction sections 206-6 and 206-7 unless otherwise specified.
2. 4-inch x 4-inch posts shall be furnished or equivalent heavy machine service type 270 degree wing of approved quality and design.
3. All gate hinges shall be heavy duty, machinable iron or steel, including service type 270 degree wing of approved quality and design.
4. Gate posts shall be 3" x 6" pipe for 12'-0" opening and 4" x 6" pipe for 16'-0" opening.
5. Center to end posts shall be 3 x 6" pipe.
6. The angle of deflection is 30 degrees or more shall be considered a corner.
7. Square gate, cap to post with 1/2 inch round lead rivet.
8. The hinges shall be made 400-5-2000.
9. The hinges shall be made 400-5-2000.
10. Gate shall be provided with a combination spring lock and strike set of approved design.
11. Dimensions shown for Standard Gateposts and Posts are standard outside dimensions.

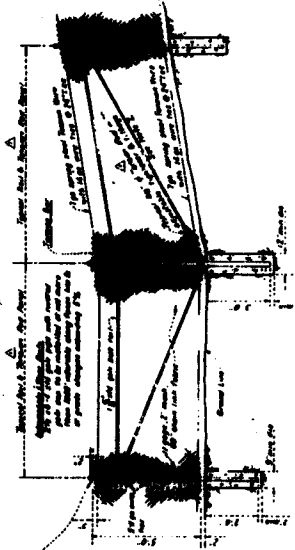

INTERMEDIATE POST DETAIL

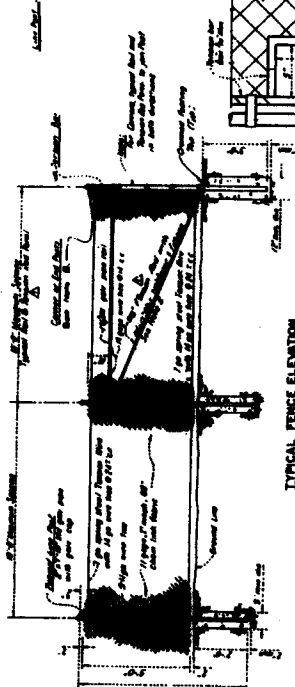

TYPICAL FENCE ELEVATION

DETAIL OF CUTOFF FOR CORNER AND LOCK

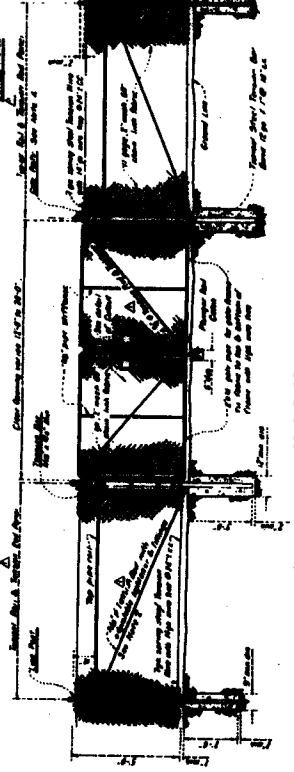

DOUBLE DRIVE GATE DETAIL



TYPICAL WALK GATE

LOS ANGELES COUNTY FLOOD CONTROL DISTRICT	
TYPICAL FENCE AND GATE	
DETAILS - FOR	
CHANNEL RIGHTS-OF-WAY	
DATE	DRAWING NO. 2-5118
BY	REVISED

NO.	REVISIONS
1	As Shown
2	Change Gatepost to 4" x 6" pipe
3	Change Gate Hinge to 400-5-2000
4	Change Gate Lock to 400-5-2000
5	Change Gate Strike to 400-5-2000

Separate Drawing No. 2-5119 shall apply.

D. B. Mann

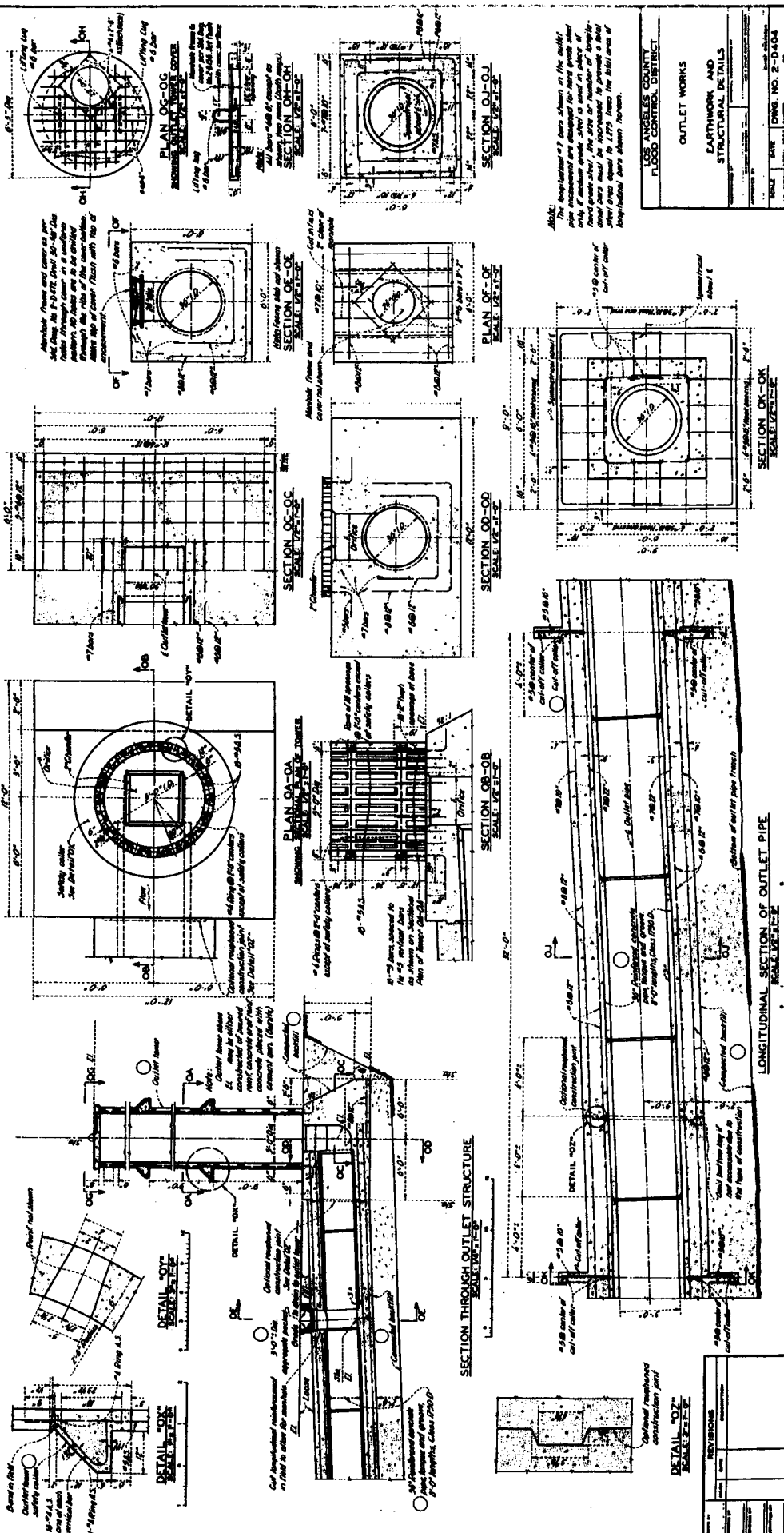

NOTE: The longitudinal bars shown in the utility pipe cross-sections are designed for large ground movement (see notes on sheet OC-01). The longitudinal bars must be expressed to provide a full shear stress equal to 1750 times the yield stress of designated bars shown herein.

PROJECT	WATER CONTROL DISTRICT
DATE	11/15/60
SCALE	1/8" = 1'-0"
DWG. NO.	2-D-404
DESIGNED BY	
CHECKED BY	
APPROVED BY	
REVISIONS	

Revised 2-60 D. B. Mann.

Major Divisions	Group Symbols	Typical Names	Field Identification Procedures (Excluding particles larger than 3 inches and leaving fractions on estimated weights)	Information Required for Describing Soils	Laboratory Classification Criteria	Group Symbols		
<p>1. More than half of material is heavier than No. 200</p> <p>2. More than half of material is lighter than No. 200</p> <p>3. For visual classification, the No. 200 sieve must be used.</p> <p>4. For visual classification, the No. 200 sieve must be used.</p> <p>5. More than half of material is heavier than No. 200</p> <p>6. More than half of material is lighter than No. 200</p> <p>7. For visual classification, the No. 200 sieve must be used.</p>	3	Well-graded gravels, gravel-sand mixtures, little or no fines.	Wide range in grain sizes and substantial amounts of all intermediate particle sizes.	For undisturbed soils add information on stratification, degree of compaction, cementation, moisture conditions and drainage characteristics.	<p>8. $C_u > 160$ Greater than 4</p> <p>9. $C_c > 1$ (D₃₀)² Between one and 3</p> <p>10. Not meeting all gradation requirements for GW</p> <p>11. Above "A" line with PI between 4 and 7</p> <p>12. Above "A" line with PI less than 4</p> <p>13. Above "U" line with PI greater than 7</p> <p>14. Above "U" line with PI greater than 7</p> <p>15. Above "U" line with PI greater than 7</p> <p>16. Above "U" line with PI greater than 7</p> <p>17. Above "U" line with PI greater than 7</p> <p>18. Above "U" line with PI greater than 7</p> <p>19. Above "U" line with PI greater than 7</p> <p>20. Above "U" line with PI greater than 7</p>	6		
	4	Poorly-graded gravels, gravel-sand mixtures, little or no fines.	Substantially one size or a range of sizes with some intermediate sizes missing.	Give typical name; indicate approximate percentages of sand and gravel, silt, clay, organic matter, moisture conditions and drainage characteristics. Other pertinent descriptive information; and symbol in parentheses.		GW, GP, GM, GC, GU, GZ, SW, SP, SM, SC	6	
	5	Silty gravels, gravel-sand-clay mixtures.	Plastic fines (for identification procedures see CL below)	Wide range in grain sizes and substantial amounts of all intermediate particle sizes.		Give typical name; indicate approximate percentages of sand and gravel, silt, clay, organic matter, moisture conditions and drainage characteristics. Other pertinent descriptive information; and symbol in parentheses.	GM, GP, GM, GC, GU, GZ, SW, SP, SM, SC	6
	6	Clays (gravel), gravel-sand-clay mixtures.	Plastic fines (for identification procedures see CL below)	Wide range in grain sizes and substantial amounts of all intermediate particle sizes.		Give typical name; indicate approximate percentages of sand and gravel, silt, clay, organic matter, moisture conditions and drainage characteristics. Other pertinent descriptive information; and symbol in parentheses.	GM, GP, GM, GC, GU, GZ, SW, SP, SM, SC	6
	7	Silty sands, sand-silt mixtures.	Plastic fines (for identification procedures see CL below)	Substantially one size or a range of sizes with some intermediate sizes missing.		Give typical name; indicate approximate percentages of sand and gravel, silt, clay, organic matter, moisture conditions and drainage characteristics. Other pertinent descriptive information; and symbol in parentheses.	GM, GP, GM, GC, GU, GZ, SW, SP, SM, SC	6
	8	Clayey sands, sand-clay mixtures.	Plastic fines (for identification procedures see CL below)	Substantially one size or a range of sizes with some intermediate sizes missing.		Give typical name; indicate approximate percentages of sand and gravel, silt, clay, organic matter, moisture conditions and drainage characteristics. Other pertinent descriptive information; and symbol in parentheses.	GM, GP, GM, GC, GU, GZ, SW, SP, SM, SC	6
	9	Silty silts and very fine sands.	Plastic fines (for identification procedures see CL below)	Substantially one size or a range of sizes with some intermediate sizes missing.		Give typical name; indicate approximate percentages of sand and gravel, silt, clay, organic matter, moisture conditions and drainage characteristics. Other pertinent descriptive information; and symbol in parentheses.	GM, GP, GM, GC, GU, GZ, SW, SP, SM, SC	6
	10	Inorganic silts and clays (fine sand) or clayey silts with slight plasticity.	Plastic fines (for identification procedures see CL below)	Substantially one size or a range of sizes with some intermediate sizes missing.		Give typical name; indicate approximate percentages of sand and gravel, silt, clay, organic matter, moisture conditions and drainage characteristics. Other pertinent descriptive information; and symbol in parentheses.	GM, GP, GM, GC, GU, GZ, SW, SP, SM, SC	6
	11	Inorganic clays of low to medium plasticity, gravelly clays, sandy clays, silty clays, lean clays.	Plastic fines (for identification procedures see CL below)	Substantially one size or a range of sizes with some intermediate sizes missing.		Give typical name; indicate approximate percentages of sand and gravel, silt, clay, organic matter, moisture conditions and drainage characteristics. Other pertinent descriptive information; and symbol in parentheses.	GM, GP, GM, GC, GU, GZ, SW, SP, SM, SC	6
	12	Clayey silts and organic silty clays of low plasticity.	Plastic fines (for identification procedures see CL below)	Substantially one size or a range of sizes with some intermediate sizes missing.		Give typical name; indicate approximate percentages of sand and gravel, silt, clay, organic matter, moisture conditions and drainage characteristics. Other pertinent descriptive information; and symbol in parentheses.	GM, GP, GM, GC, GU, GZ, SW, SP, SM, SC	6
	13	Inorganic silts, macaceous or discontinuous fine sandy or silty soils, plastic silts.	Plastic fines (for identification procedures see CL below)	Substantially one size or a range of sizes with some intermediate sizes missing.		Give typical name; indicate approximate percentages of sand and gravel, silt, clay, organic matter, moisture conditions and drainage characteristics. Other pertinent descriptive information; and symbol in parentheses.	GM, GP, GM, GC, GU, GZ, SW, SP, SM, SC	6
	14	Inorganic clays of high plasticity, fat clays.	Plastic fines (for identification procedures see CL below)	Substantially one size or a range of sizes with some intermediate sizes missing.		Give typical name; indicate approximate percentages of sand and gravel, silt, clay, organic matter, moisture conditions and drainage characteristics. Other pertinent descriptive information; and symbol in parentheses.	GM, GP, GM, GC, GU, GZ, SW, SP, SM, SC	6
15	Organic clays of medium to high plasticity, organic silts.	Plastic fines (for identification procedures see CL below)	Substantially one size or a range of sizes with some intermediate sizes missing.	Give typical name; indicate approximate percentages of sand and gravel, silt, clay, organic matter, moisture conditions and drainage characteristics. Other pertinent descriptive information; and symbol in parentheses.	GM, GP, GM, GC, GU, GZ, SW, SP, SM, SC	6		
16	Peat and other highly organic soils.	Plastic fines (for identification procedures see CL below)	Substantially one size or a range of sizes with some intermediate sizes missing.	Give typical name; indicate approximate percentages of sand and gravel, silt, clay, organic matter, moisture conditions and drainage characteristics. Other pertinent descriptive information; and symbol in parentheses.	GM, GP, GM, GC, GU, GZ, SW, SP, SM, SC	6		

FIELD IDENTIFICATION PROCEDURES FOR FINE-GRAINED SOILS OR FRACTIONS

These procedures are to be performed on the sizes No. 40 sieve particles, approximately 1/41 in. For field classification purposes, screening is not intended; simply remove by hand the coarse particles that interfere with the tests.

Dilatancy (Reaction to Shaking)

1. Take a representative sample of soil (No. 40 sieve) and place it in a jar or bucket. Add enough water if necessary to make the soil just moist. Place the jar in the open mouth of one hand and shake horizontally, striking vigorously against the side of the other hand. Observe the reaction of the soil to the shaking. If the soil is highly plastic, it will become very lumpy and will not flow. If the soil is medium plastic, it will become lumpy and will not flow. If the soil is low plastic, it will become lumpy and will not flow. If the soil is non-plastic, it will flow freely.

Dry Strength (Crushing Characteristics)

1. Take a representative sample of soil (No. 40 sieve) and place it in a jar or bucket. Add enough water if necessary to make the soil just moist. Place the jar in the open mouth of one hand and shake horizontally, striking vigorously against the side of the other hand. Observe the reaction of the soil to the shaking. If the soil is highly plastic, it will become very lumpy and will not flow. If the soil is medium plastic, it will become lumpy and will not flow. If the soil is low plastic, it will become lumpy and will not flow. If the soil is non-plastic, it will flow freely.

Toughness (Consistency with Plastic Limit)

1. Take a representative sample of soil (No. 40 sieve) and place it in a jar or bucket. Add enough water if necessary to make the soil just moist. Place the jar in the open mouth of one hand and shake horizontally, striking vigorously against the side of the other hand. Observe the reaction of the soil to the shaking. If the soil is highly plastic, it will become very lumpy and will not flow. If the soil is medium plastic, it will become lumpy and will not flow. If the soil is low plastic, it will become lumpy and will not flow. If the soil is non-plastic, it will flow freely.

PLASTICITY CHART

For laboratory classification of fine-grained soils

APPROVAL, RECOMMENDED BY

[Signature]

LOS ANGELES COUNTY FLOOD CONTROL DISTRICT

UNIFIED SOIL CLASSIFICATION SYSTEM

APPROVED BY: *[Signature]*

NO. 2-D413

DATE: 3-22-65

SCALE: NONE

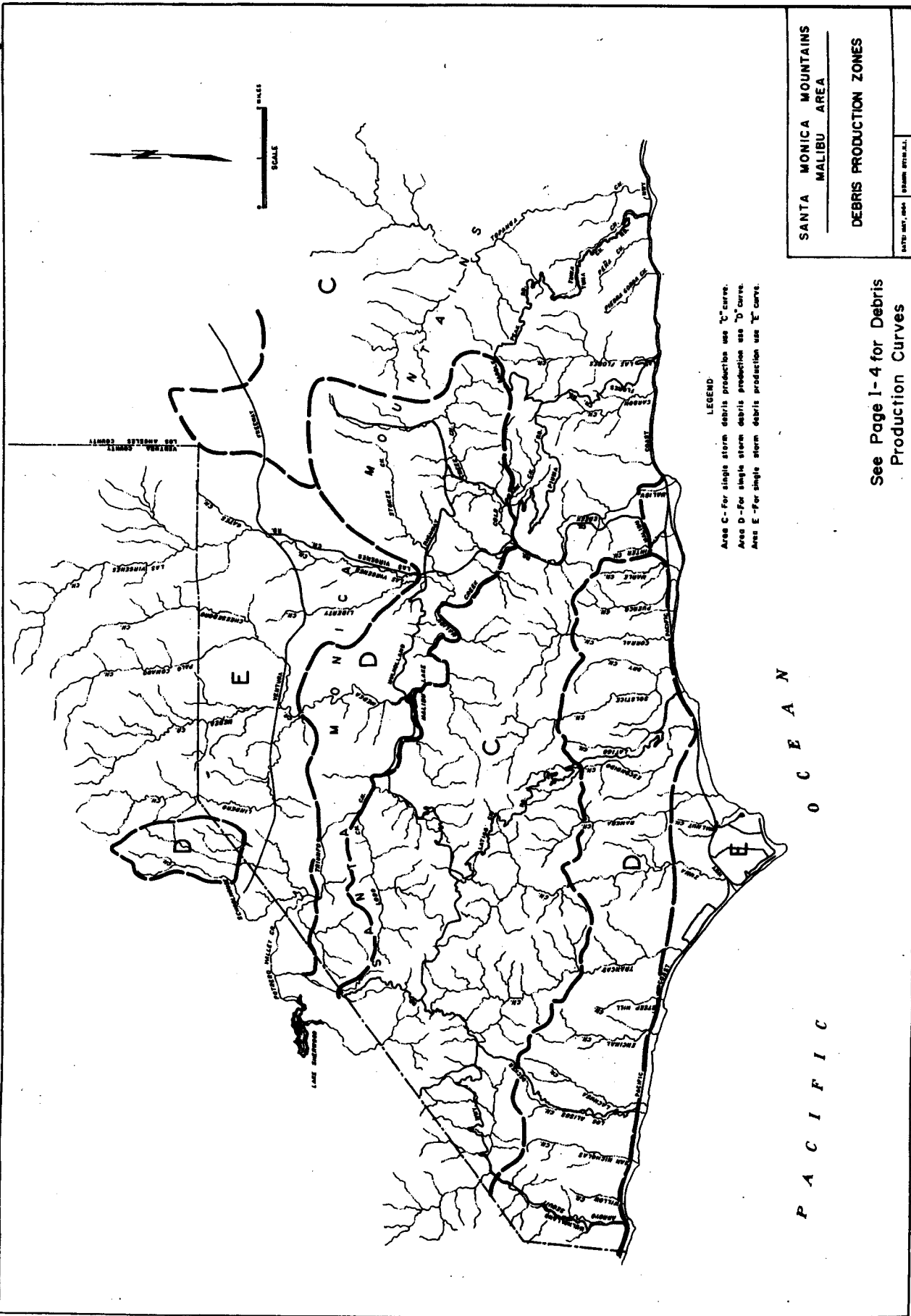

LEGEND
 Area C - For single storm debris production use "C" curve.
 Area D - For single storm debris production use "D" curve.
 Area E - For single storm debris production use "E" curve.

**SANTA MONICA MOUNTAINS
 MALIBU AREA**

DEBRIS PRODUCTION ZONES

See Page 1-4 for Debris
 Production Curves

P A C I F I C O C E A N

DATE: MAY, 1968
 DRAWN BY: J.L.L.

D. R. Mann.

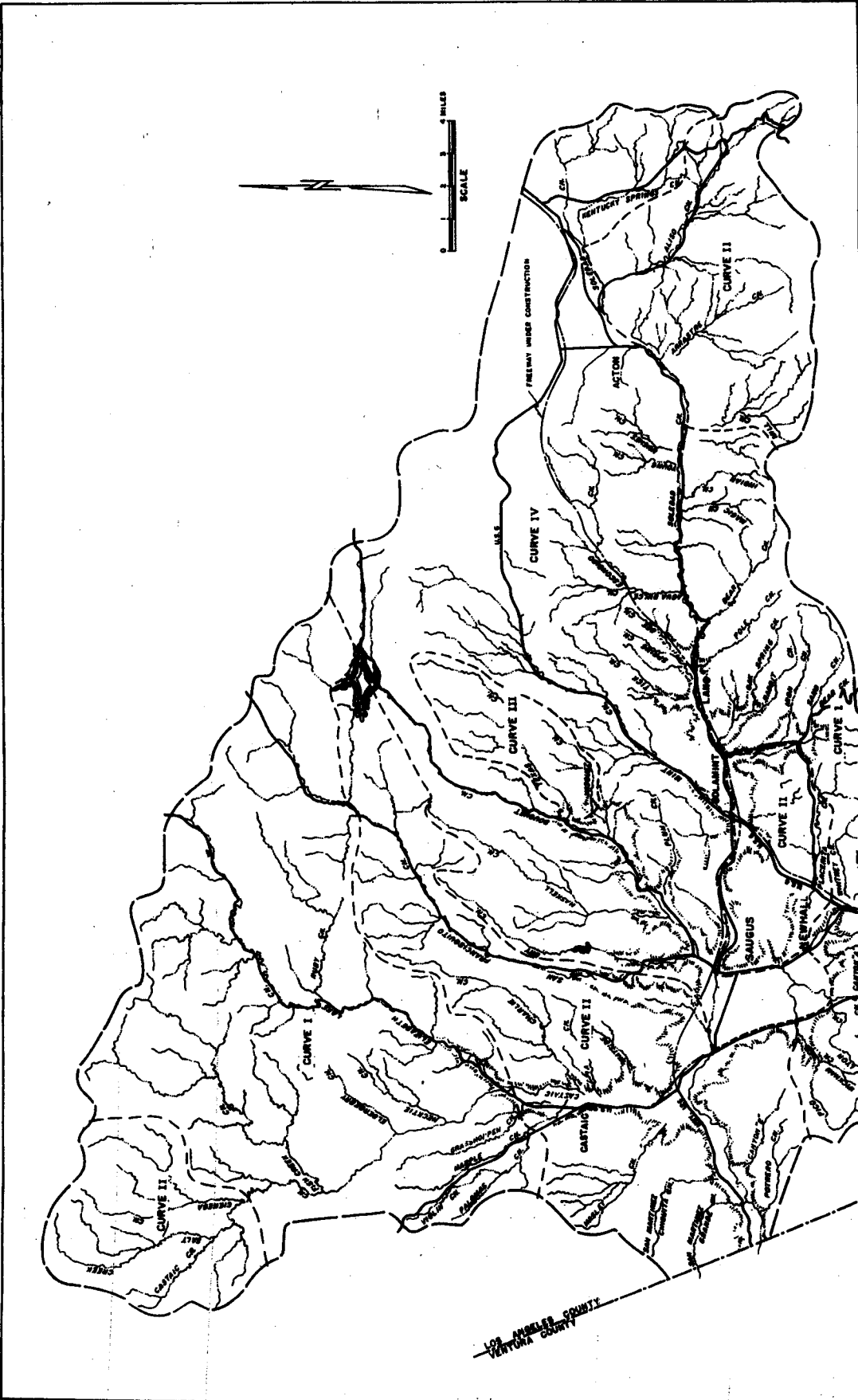
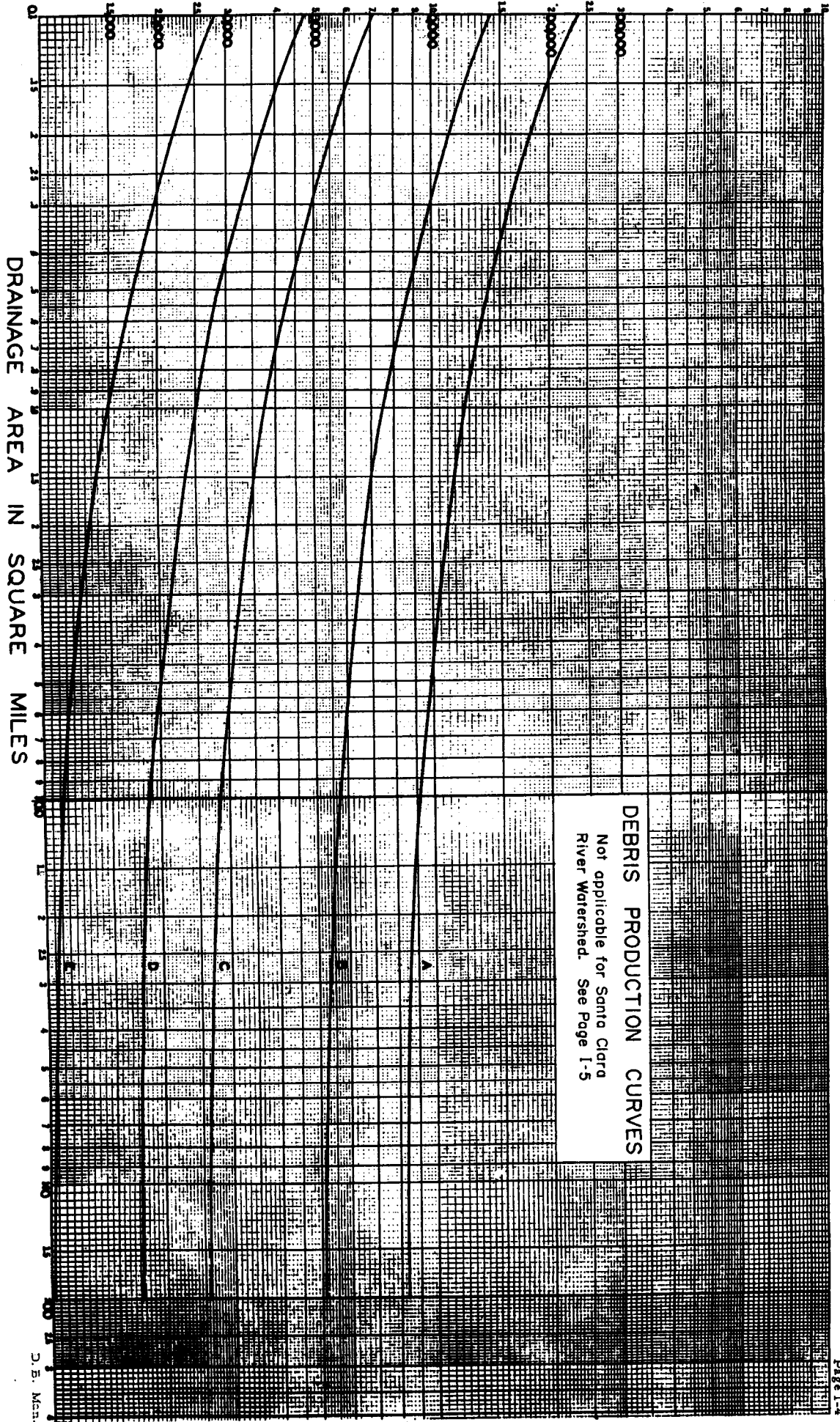

PLATE I
SANTA CLARA RIVER WATERSHED
DEBRIS PRODUCTION ZONES

See Page I-5 for Debris
Production Curves

LOS ANGELES COUNTY
VENTURA COUNTY

DEBRIS IN CUBIC YARDS PER SQUARE MILE



DEBRIS PRODUCTION CURVES
Not applicable for Santa Clara
River Watershed. See Page I-5

PLATE I
 SANTA CLARA RIVER
 WATERSHED
 DEBRIS PRODUCTION CURVES

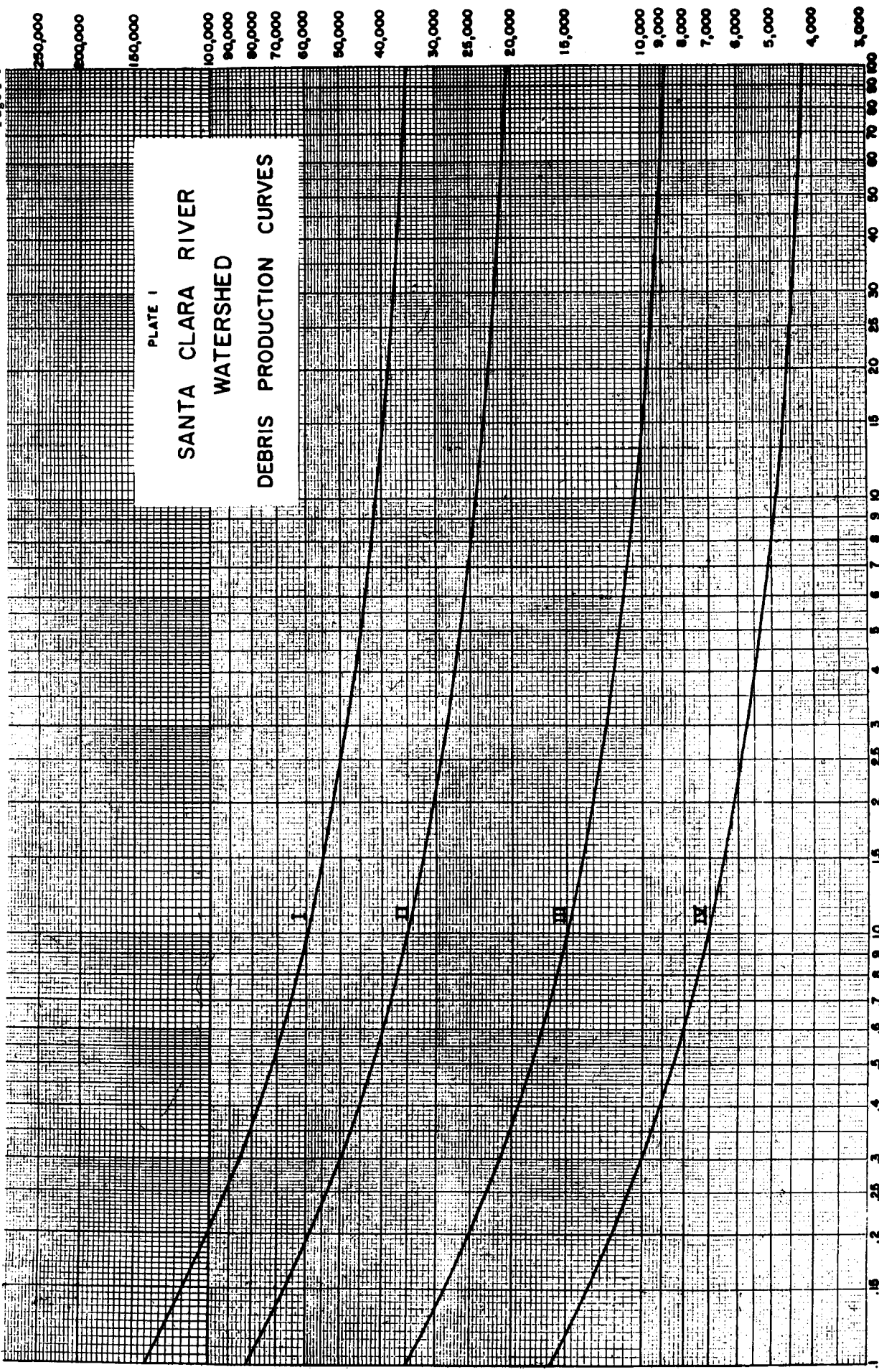

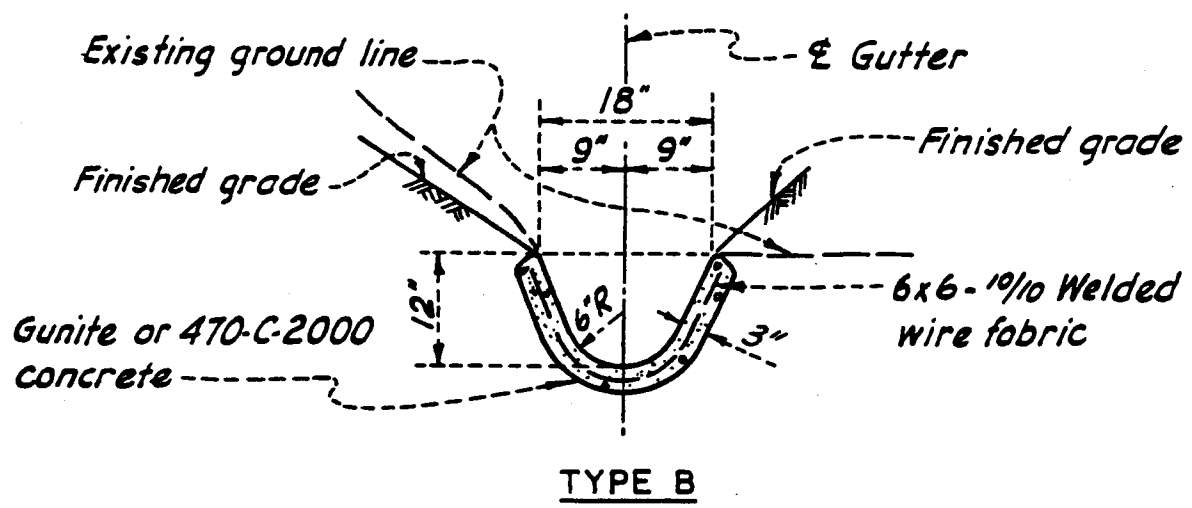
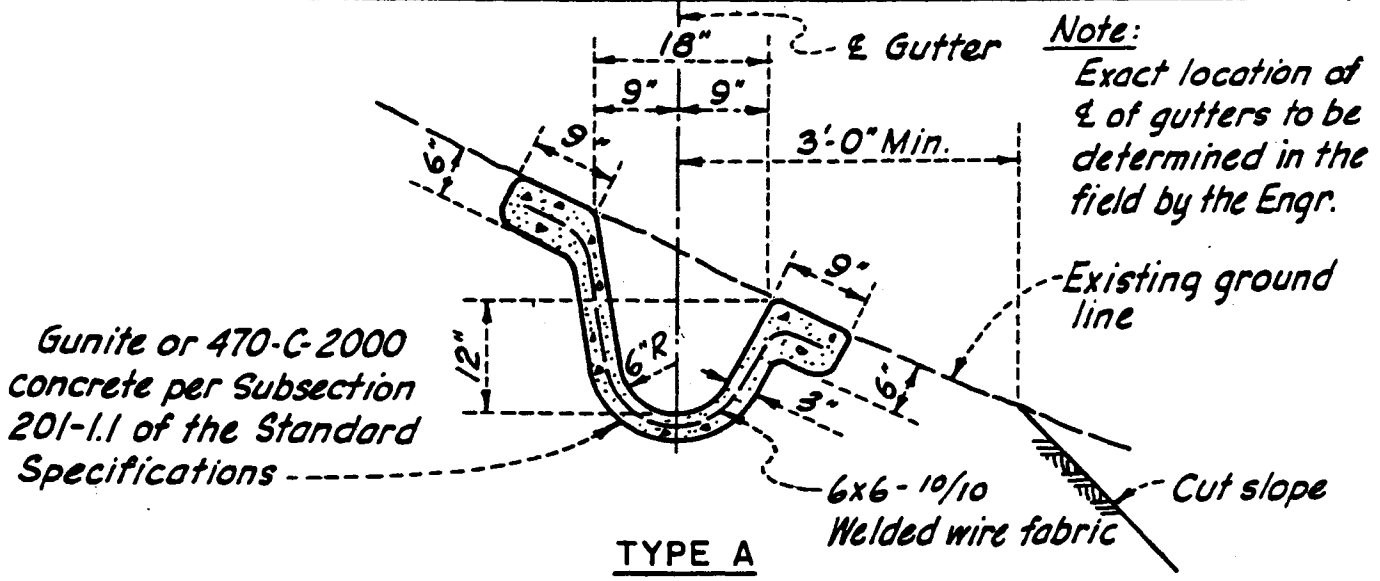

SLOPE PROTECTION GUTTERS

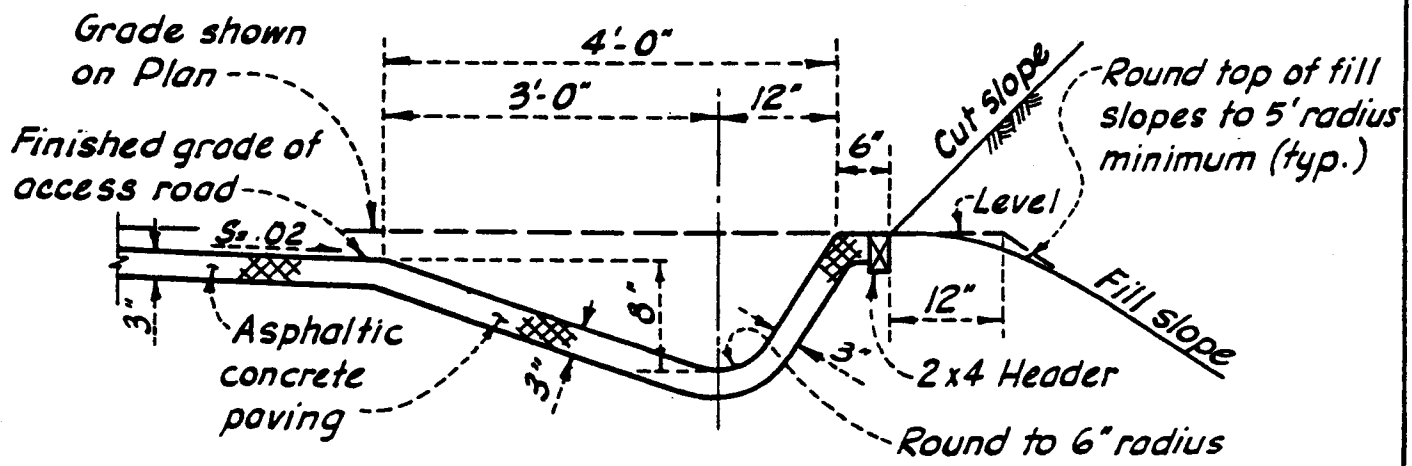
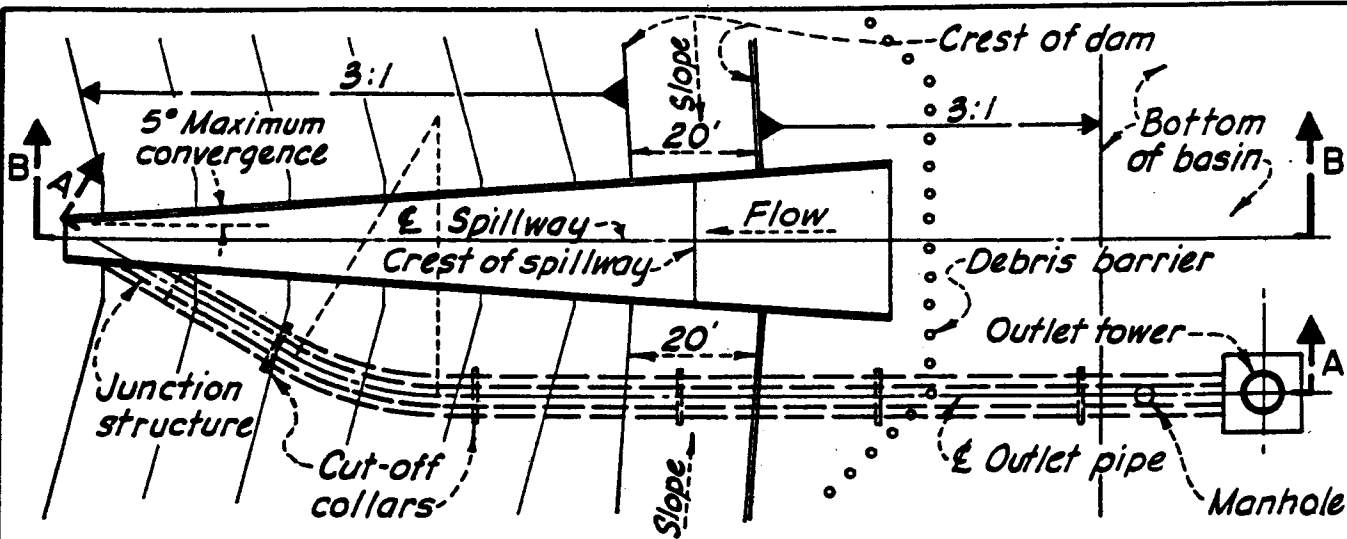
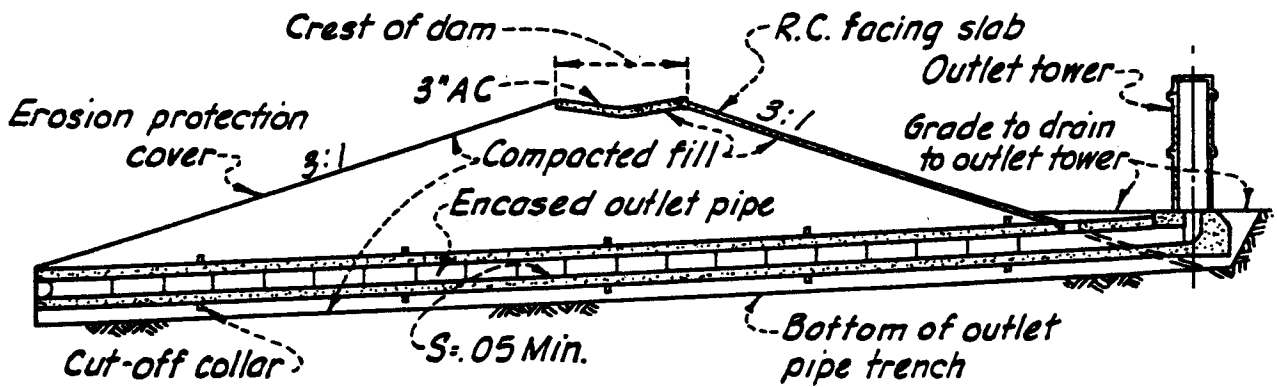

Fig. 1



PLAN
TYPICAL SPILLWAY AND OUTLET WORKS



SECTION A-A

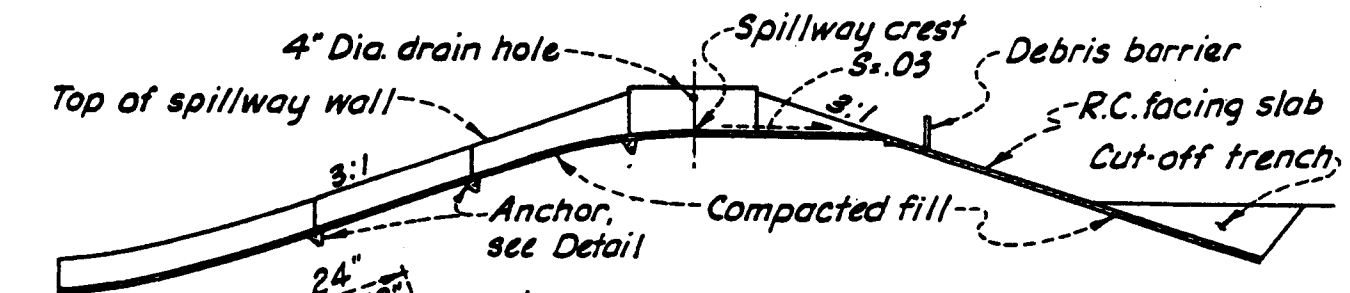

SECTION B-B

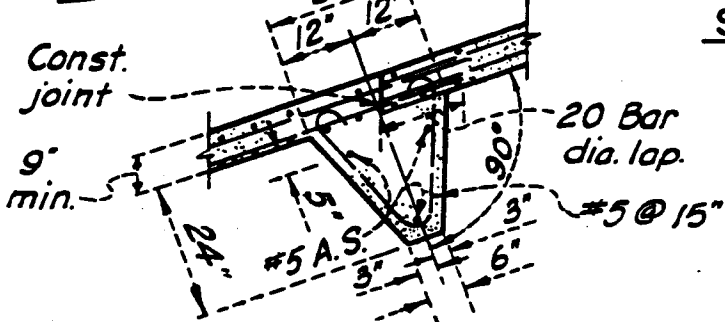

ANCHOR DETAIL

Fig. 2

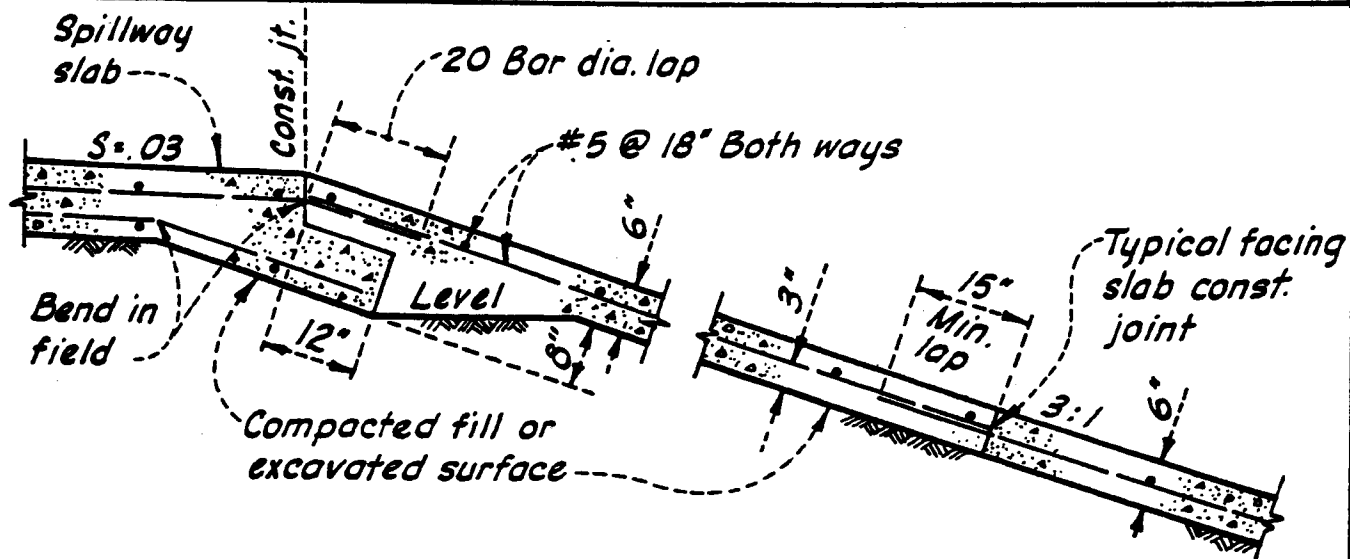

FACING SLAB DETAIL

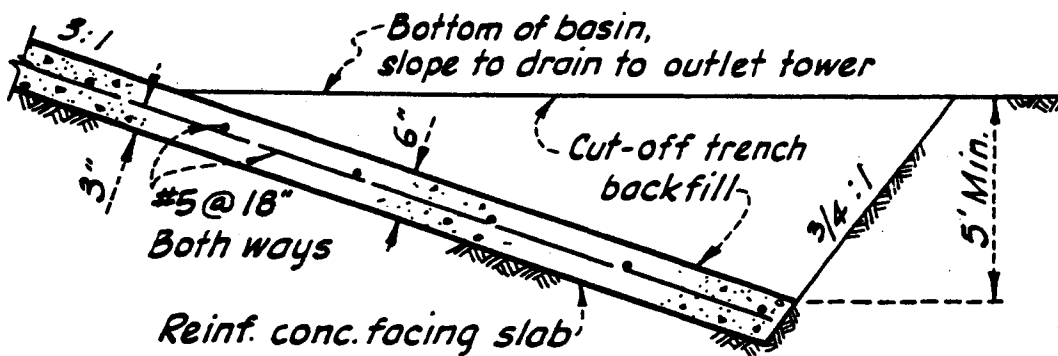

FACING SLAB CUT-OFF DETAIL

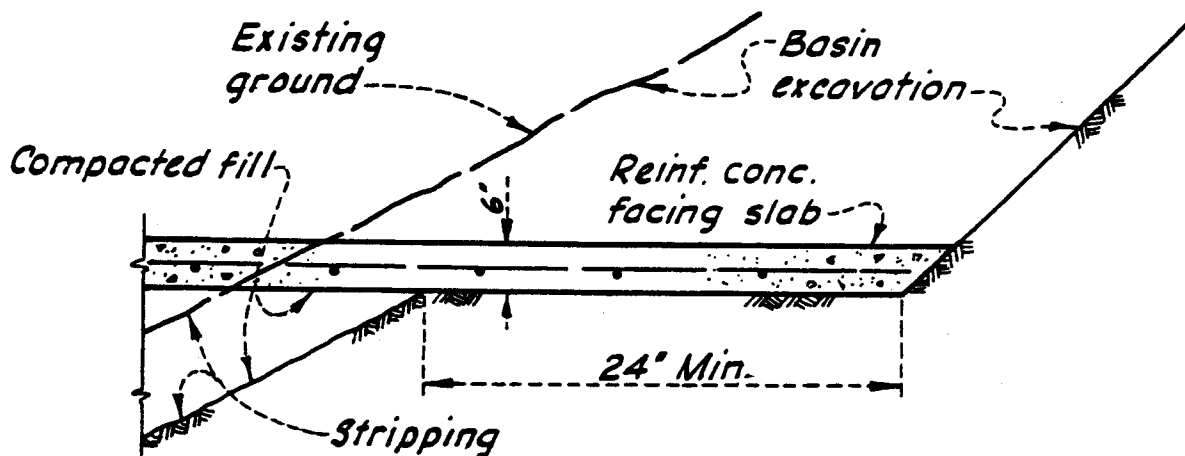

FACING SLAB DETAIL AT ABUTMENTS

Fig. 3

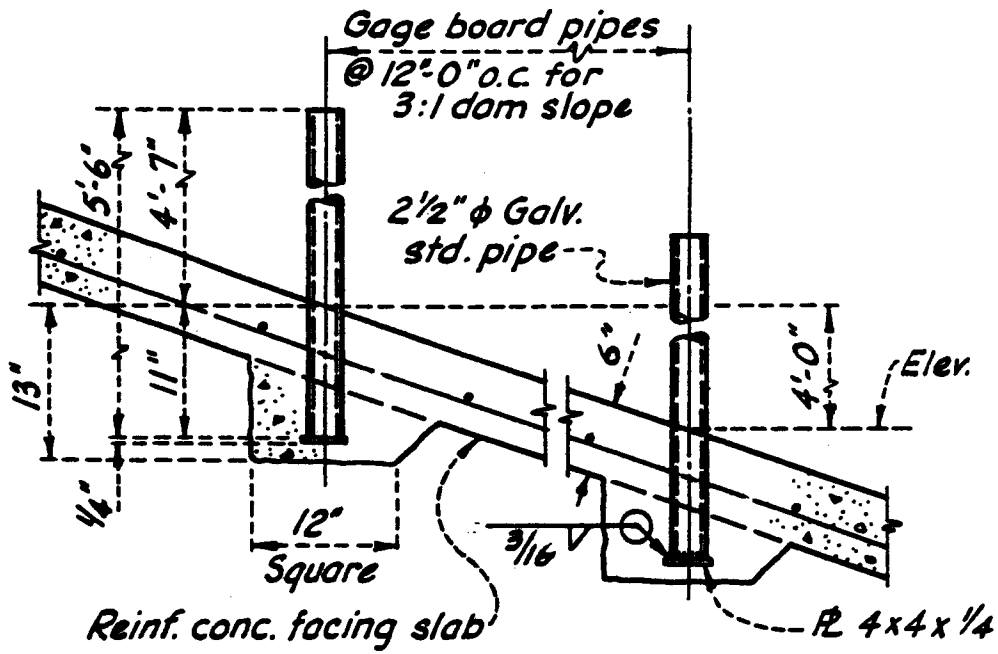

GAGE BOARD PIPE INSTALLATION

Fig. 4

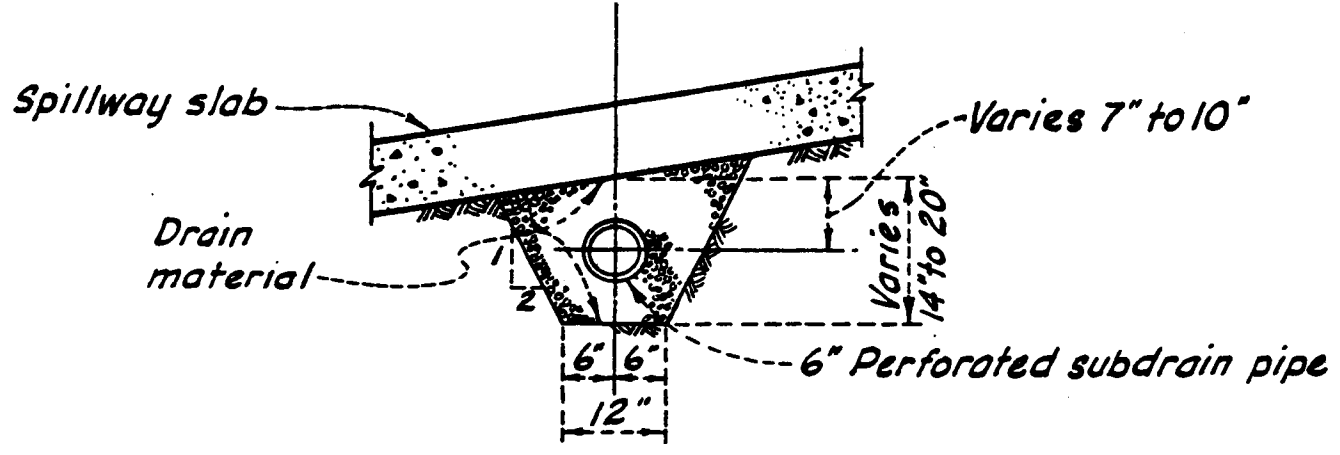
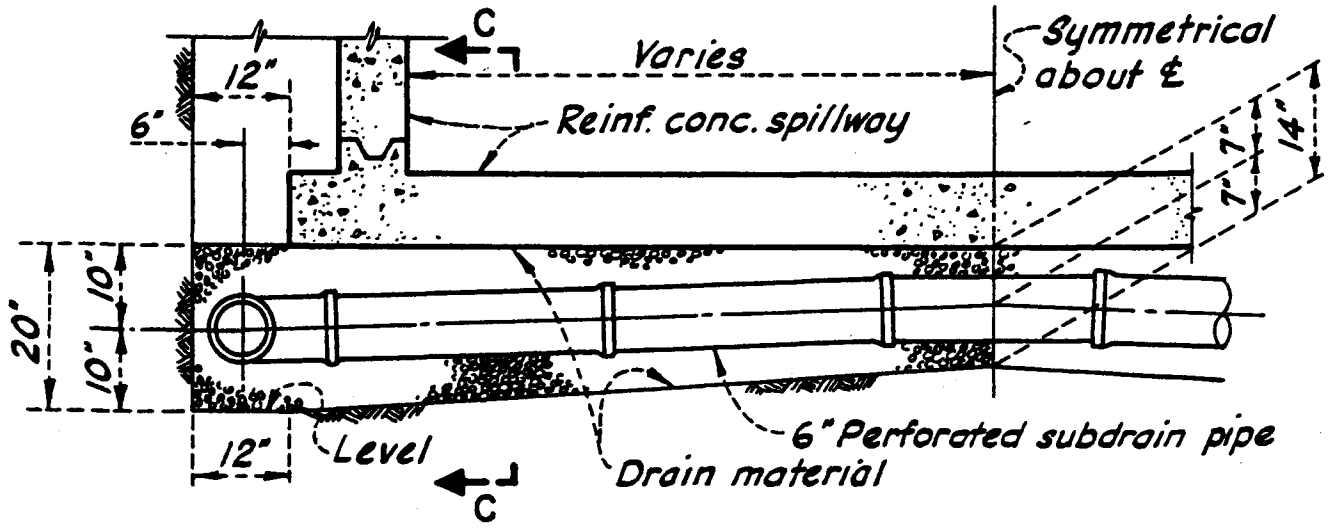

SECTION C-C
LATERAL SUBDRAIN DETAIL

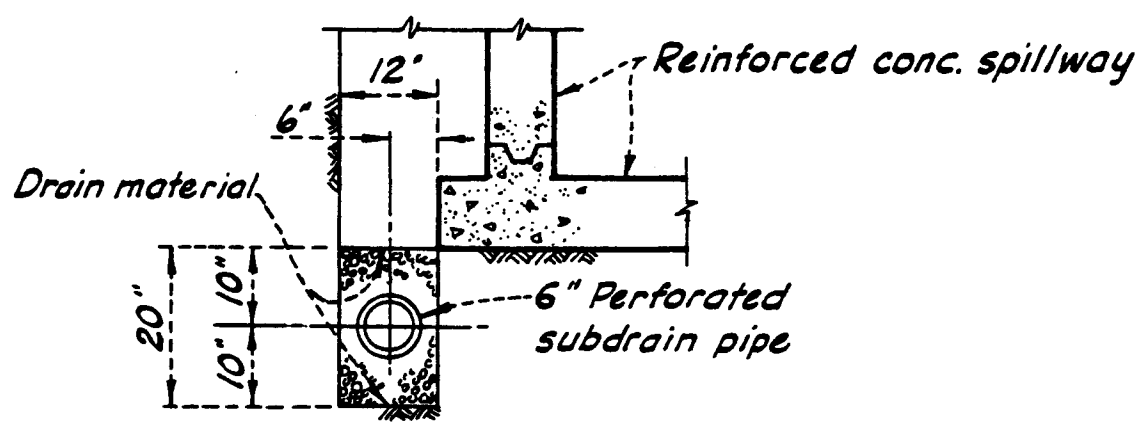

LONGITUDINAL SUBDRAIN DETAIL
BETWEEN CONNECTED LATERALS

Fig. 5

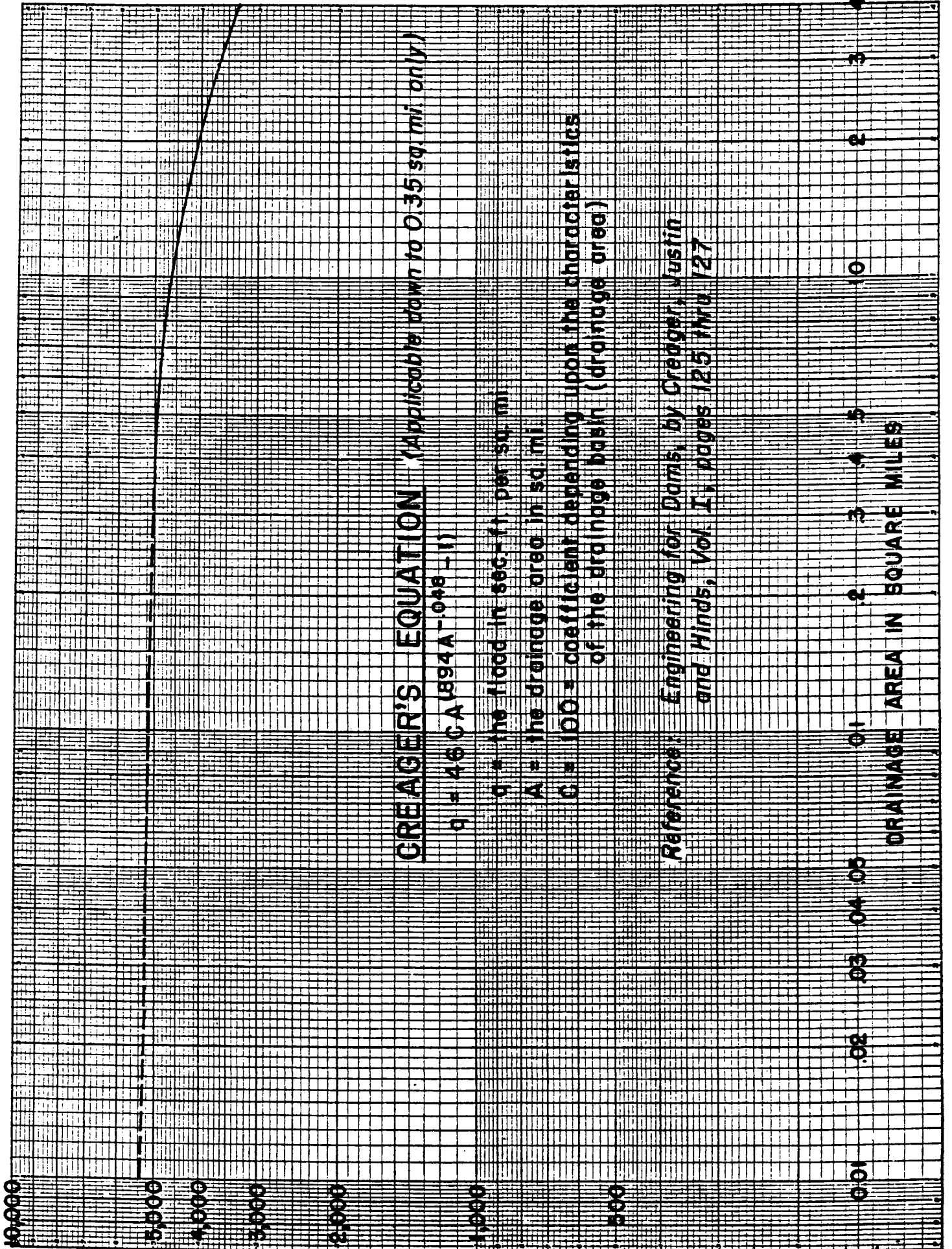

CREAGER'S EQUATION (Applicable down to 0.35 sq. mi. only)

$$q = 4.6 CA^{0.48 - 1}$$

q = the flood in sec.-ft. per sq. mi.

A = the drainage area in sq. mi.

C = 100 = coefficient depending upon the characteristics of the drainage basin (drainage area)

Reference: *Engineering for Dams, by Creager, Jusin and Hinds, Vol. I, pages 125 thru 127*

FLOOD IN CUBIC FEET PER SECOND PER SQUARE MILE

DRAINAGE AREA IN SQUARE MILES

MOMENTS AND SHEARS FOR SPILLWAY WALLS

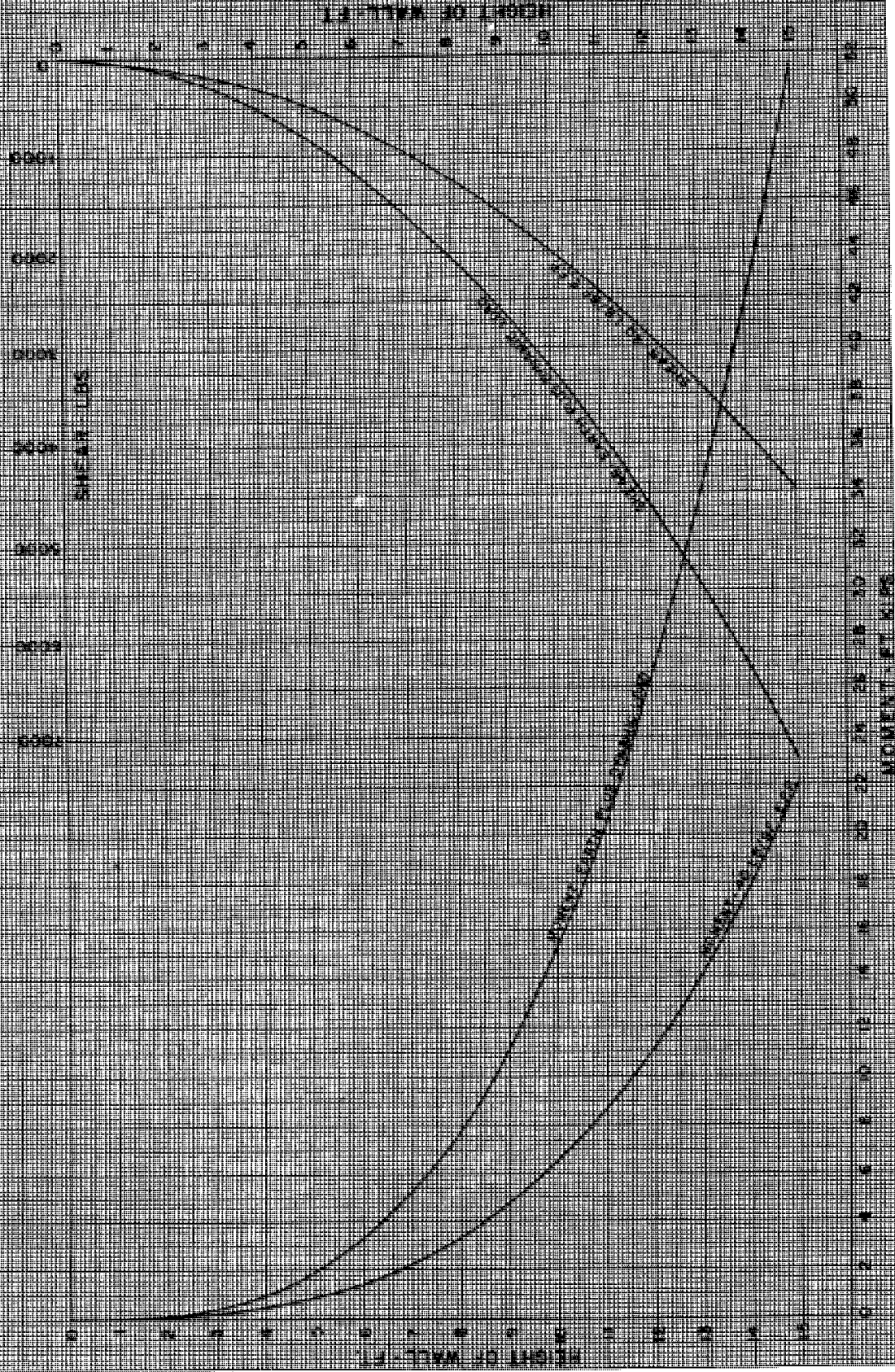

DESIGN OF INVERT SLAB FOR RECTANGULAR SPILLWAYS

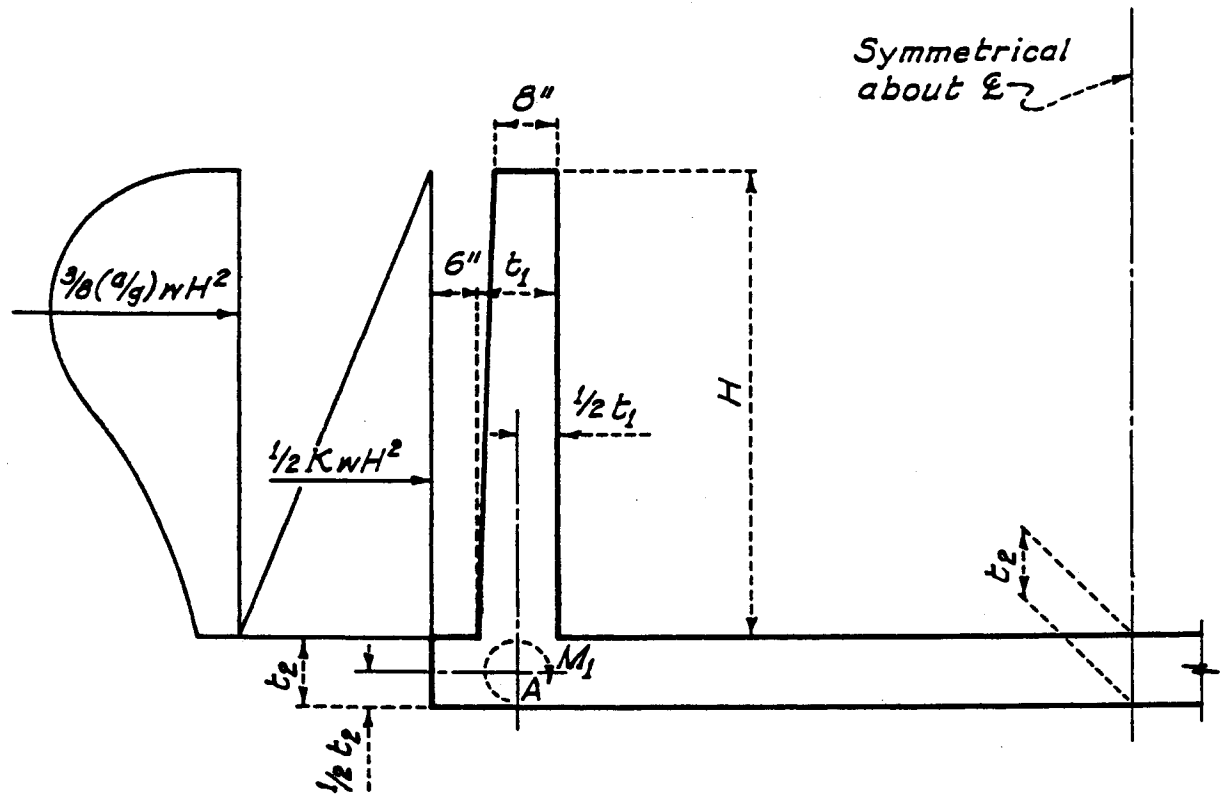

CASE I Channel Empty

M_1 = Moment at "A" due to external horizontal forces acting on wall.

WALL DIMENSIONS		
H	t_1	t_2
6'	8"	9"
8'	8"	9"
10'	8"	9 1/2"
12'	10"	12"
14'	12"	14 1/2"
16'	14"	17"

DESIGN OF INVERT SLAB FOR RECTANGULAR SPILLWAYS

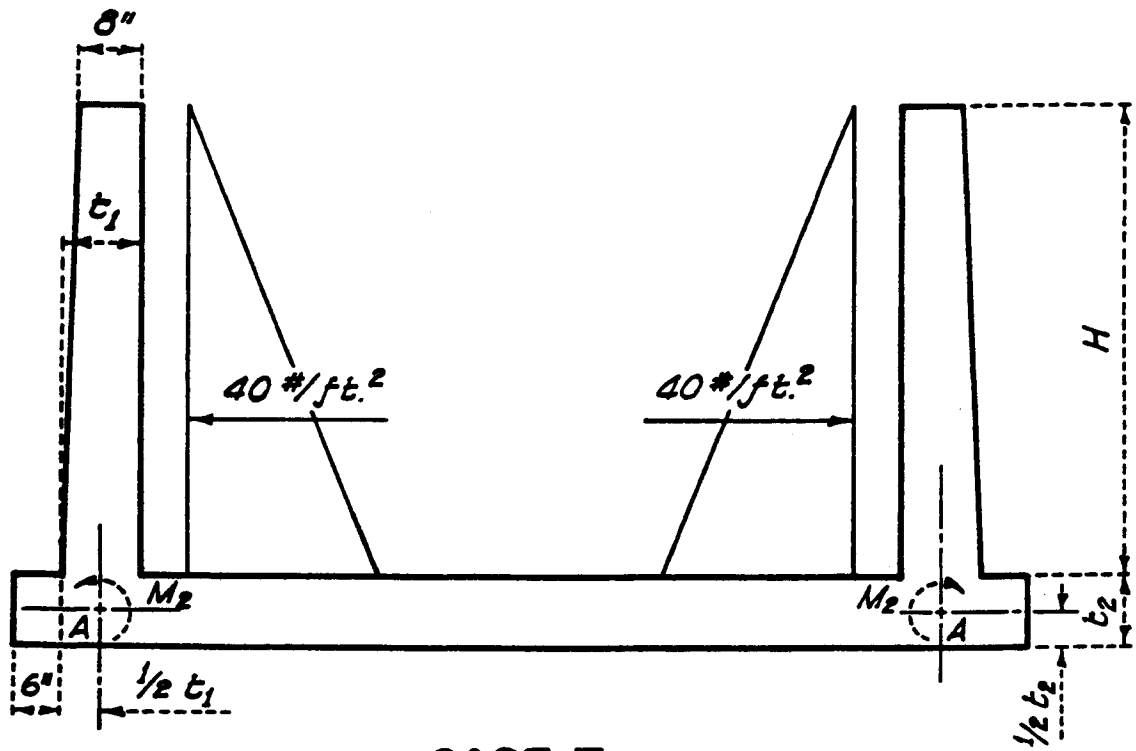

CASE II *Channel Full*

M_2 = Moment at "A" due to equivalent differential hydrostatic pressure.

For values of H , t_1 and t_2 , see Case I.

MOMENTS IN INVERT SLAB OF RECTANGULAR SPILLWAYS
6 FT HIGH WALL

CASE I

CASE II

MOMENT IN FT. LBS. PER FOOT OF SPILLWAY

DISTANCE FROM INVERT FACE OF WALL IN FT.

DISTANCE FROM INVERT FACE OF WALL IN FT.

D. B. Man.

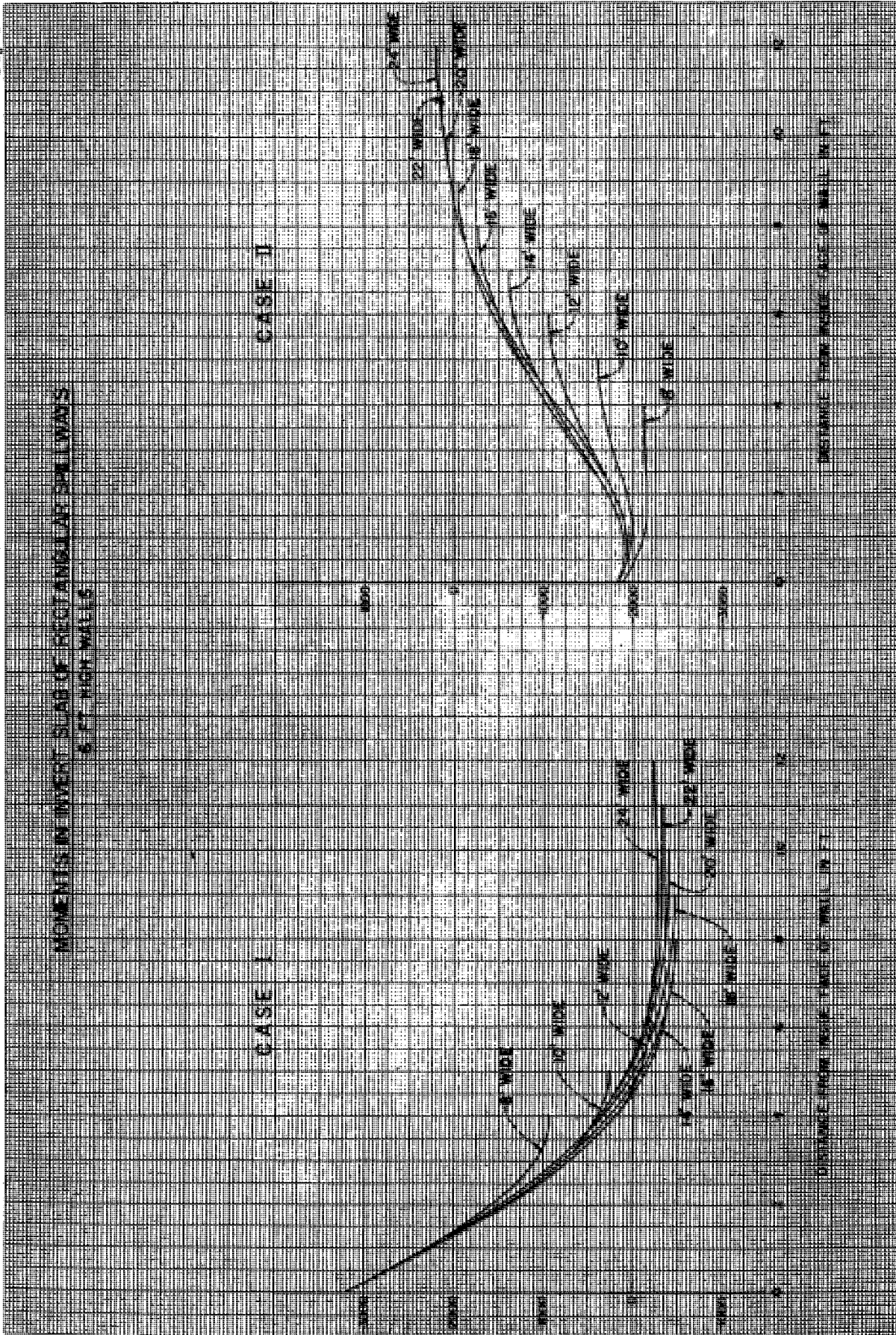

MOMENTS IN INVERT SLAB OF RECTANGULAR SPILLWAYS
6 FT HIGH WALLS

CASE I

CASE II

MOMENT IN FT. LBS. PER FOOT OF SPILLWAY

DISTANCE FROM INSIDE FACE OF WALL IN FT.

DISTANCE FROM INSIDE FACE OF WALL IN FT.

D. B. Mann.

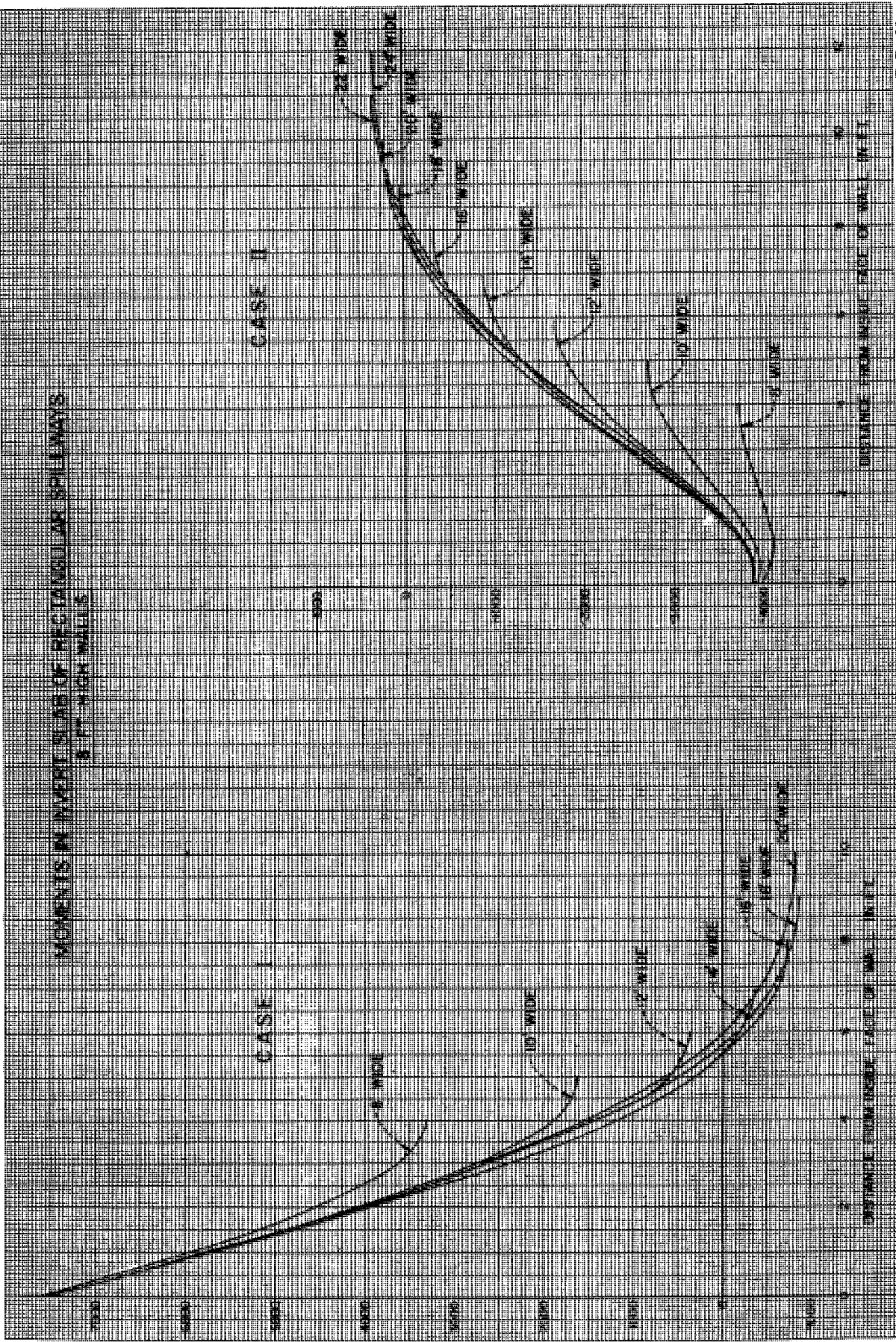

MOMENTS IN INVERT SLAB OF RECTANGULAR SPILLWAYS
10 FT. HIGH WALLS

CASE I

CASE II

10' WIDE

12' WIDE

14' WIDE

16' WIDE

18' WIDE

20' WIDE

22' WIDE

24' WIDE

26' WIDE

28' WIDE

30' WIDE

32' WIDE

34' WIDE

36' WIDE

38' WIDE

40' WIDE

42' WIDE

44' WIDE

46' WIDE

48' WIDE

50' WIDE

52' WIDE

54' WIDE

56' WIDE

58' WIDE

60' WIDE

62' WIDE

64' WIDE

66' WIDE

68' WIDE

70' WIDE

72' WIDE

74' WIDE

76' WIDE

78' WIDE

80' WIDE

82' WIDE

84' WIDE

86' WIDE

88' WIDE

90' WIDE

10'

20'

30'

40'

50'

60'

70'

80'

90'

100'

110'

120'

130'

140'

150'

160'

170'

180'

190'

200'

210'

220'

230'

240'

250'

260'

270'

280'

290'

300'

310'

320'

330'

340'

350'

360'

370'

380'

390'

400'

1000

2000

3000

4000

5000

6000

7000

8000

9000

10000

11000

12000

13000

14000

15000

16000

17000

18000

19000

20000

21000

22000

23000

24000

25000

26000

27000

28000

29000

30000

31000

32000

33000

34000

35000

36000

37000

38000

39000

40000

MOMENT IN FT. LBS. PER FOOT OF SPILLWAY

DISTANCE FROM DOWN FACE OF WALL IN FT.

DISTANCE FROM DOWN FACE OF WALL IN FT.

MOMENTS IN INVERT SLAB OF RECTANGULAR SPILLWAYS
OF 10 FT HIGH WALLS

CASE I

CASE II

MOMENT IN FT. LBS. PER FOOT OF SPILLWAY

DISTANCE FROM INVERT FACE OF WALL IN FT.

DISTANCE FROM INVERT FACE OF WALL IN FT.

D. E. Mann

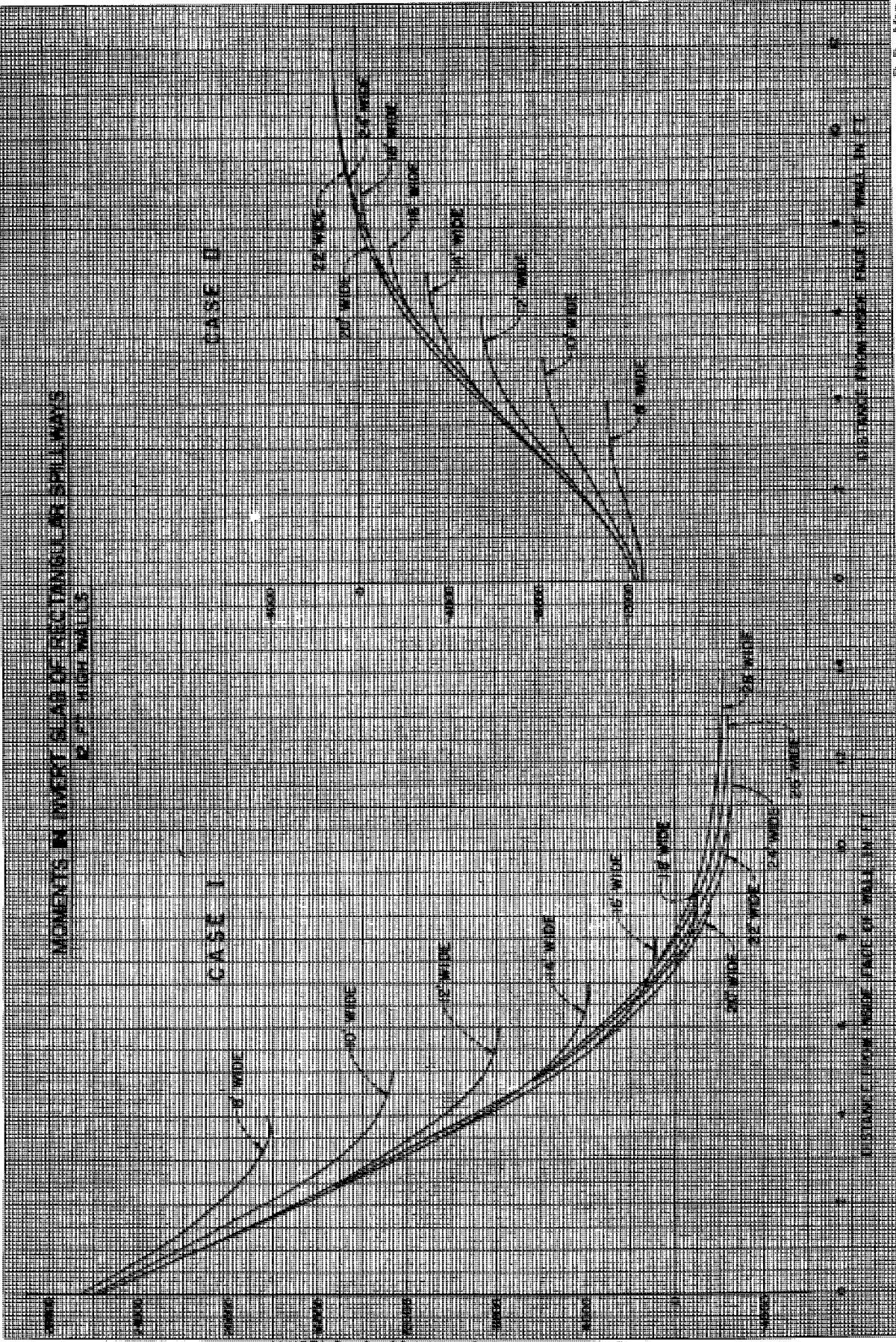

MOMENTS IN INVERT SLAB OF RECTANGULAR SPILLWAYS

4 FT. HIGH WALLS

CASE I

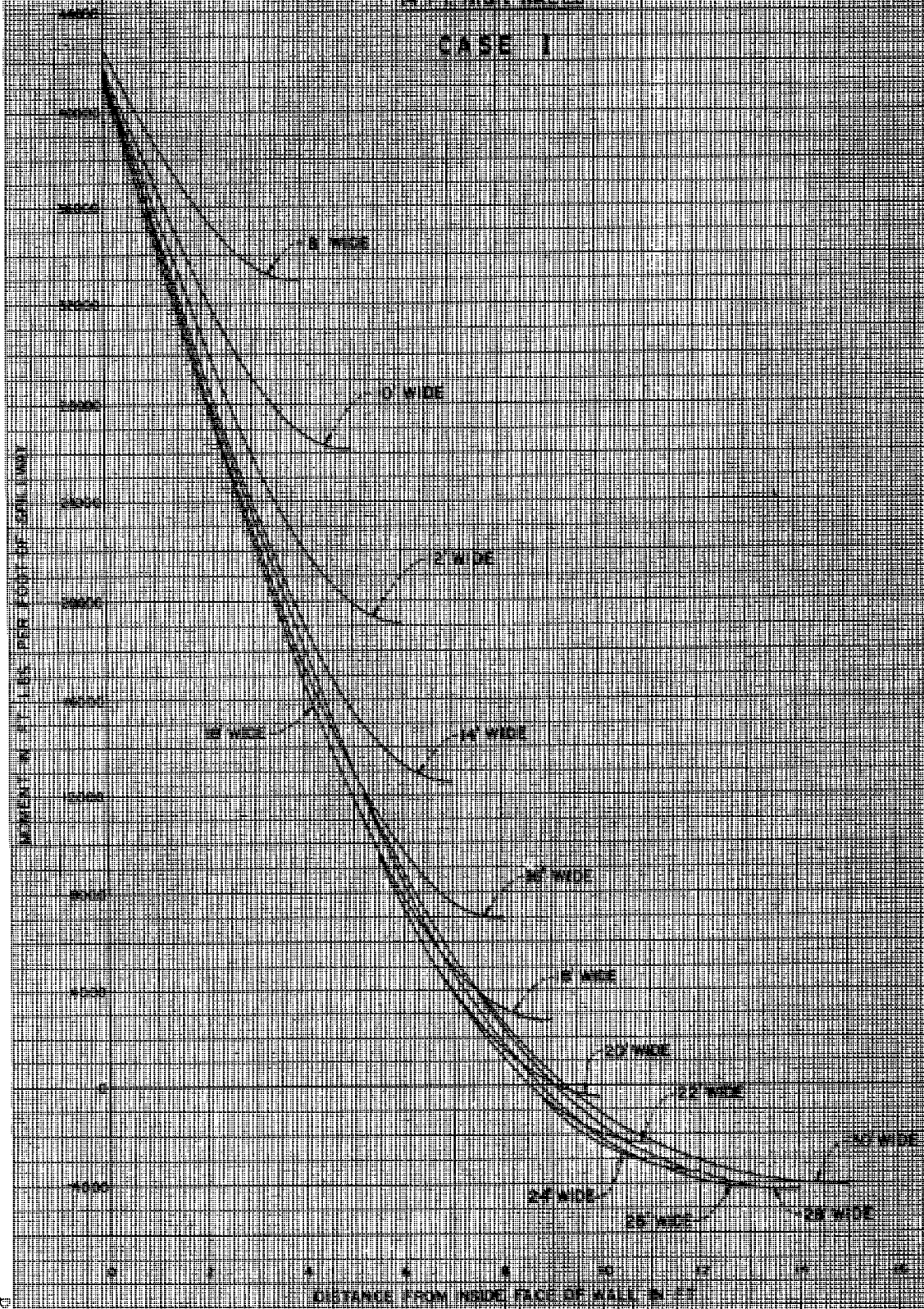

D. B. MANN

Page 119

MOMENTS IN INVERT SLAB OF RECTANGULAR SPILLWAYS 14 FT HIGH WALLS

CASE II

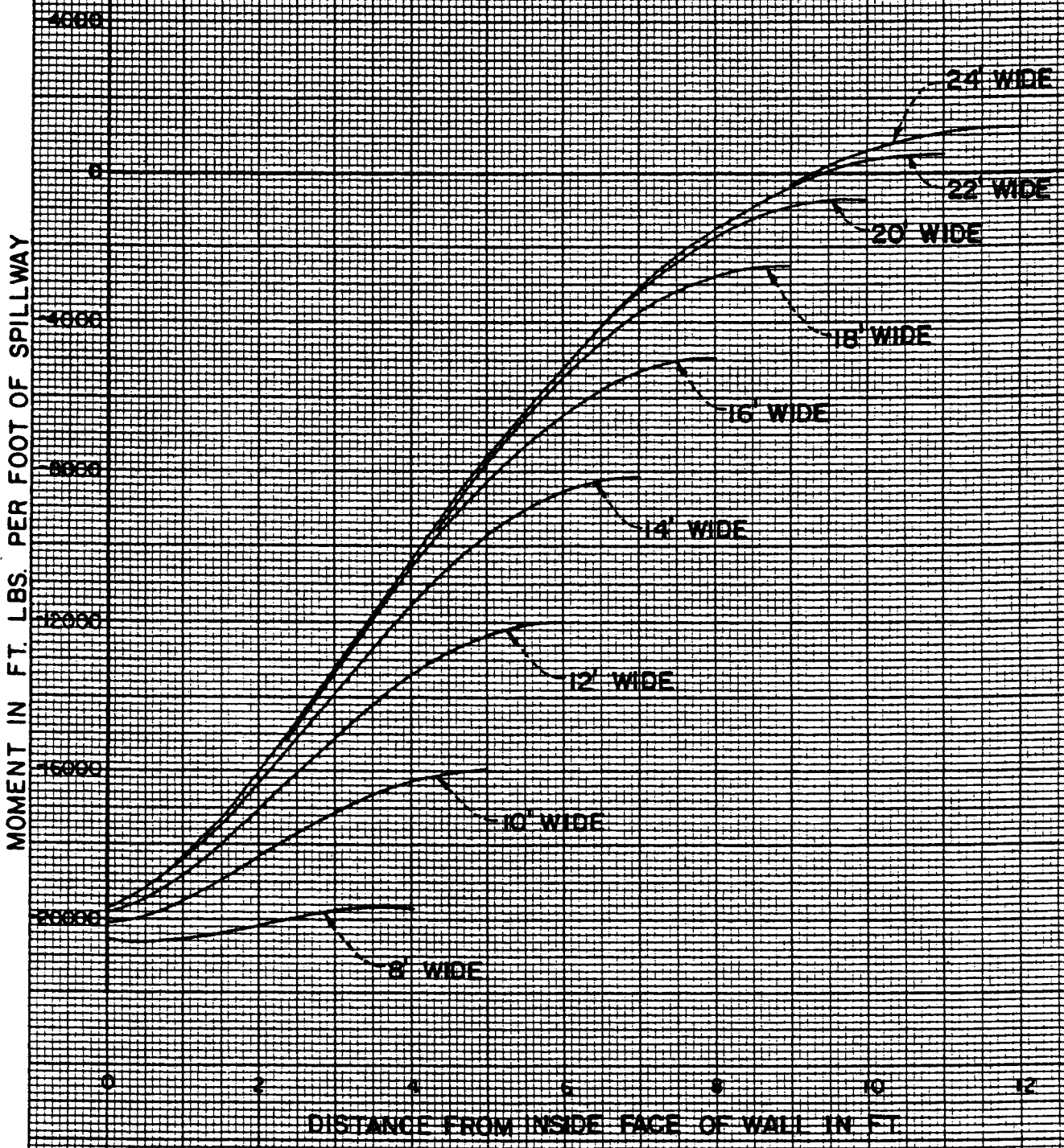

MOMENTS IN INVERT SLAB OF RECTANGULAR SPILLWAYS

6 FT. HIGH WALLS

CASE I

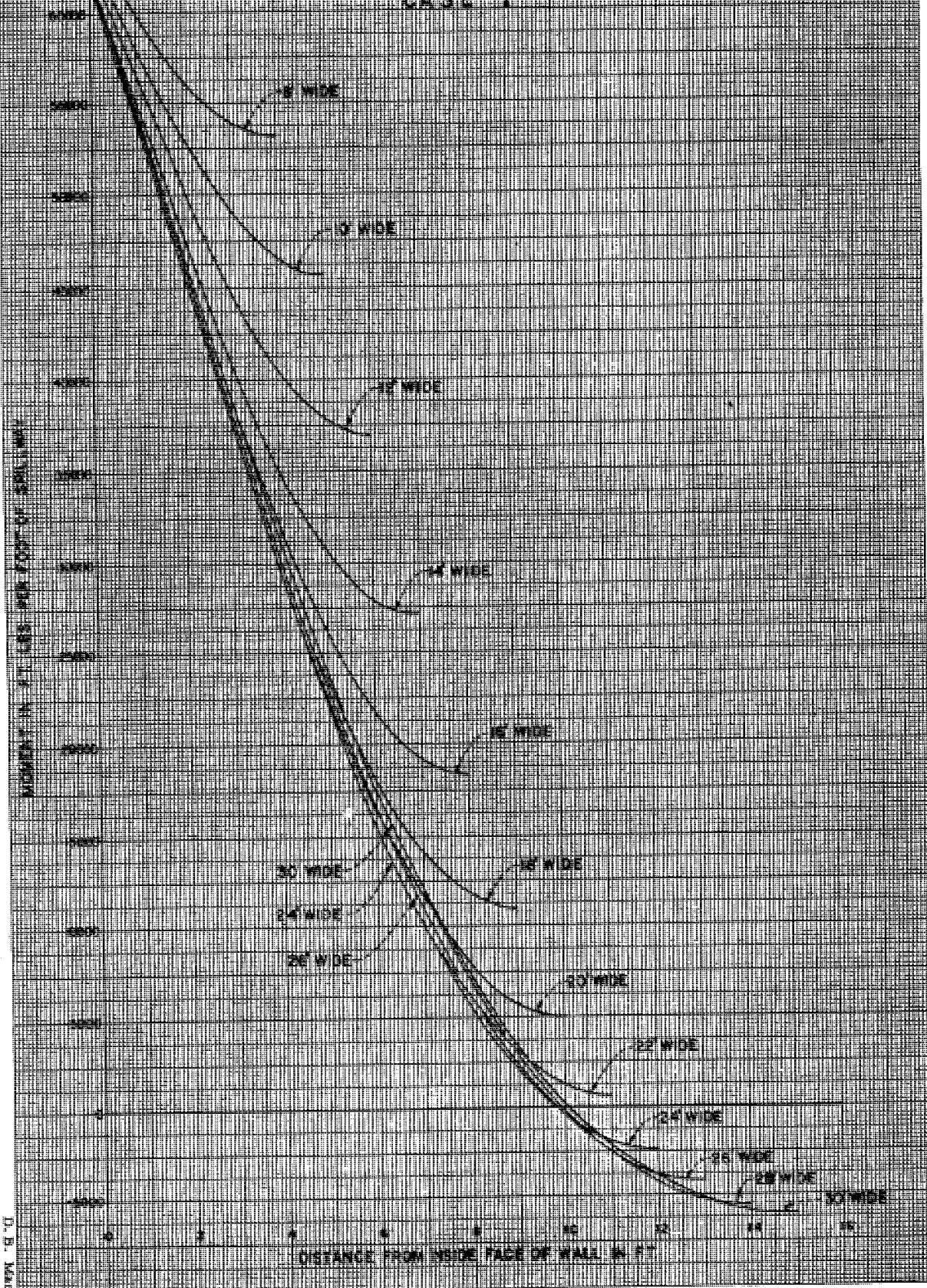

D. B. MARSH