

DIST	COUNTY	NO. 112	POST MILES - TOTAL PROJECT	SHEET NO.	TOTAL SHEETS
7	LA	405	40.28/45.00	1	17

STATE OF CALIFORNIA  
HIGHWAY TRANSPORTATION AGENCY  
DEPARTMENT OF PUBLIC WORKS  
DIVISION OF HIGHWAYS  
**MONUMENTATION MAP**  
No. MF-1938-1

*Anthony*  
Deputy District Engineer

**RAMP NO. 4**

R	Δ	T	L	N	COORDINATE	E
A	7'	92°15'49"	7.28'	11.27	175,014.14	146,202.47
B	37'	87°44'11"	35.57'	56.66	174,984.18	146,135.59
C	500'	08°53'06"	38.85'	77.54	174,723.45	146,683.16
D	500'	08°53'06"	38.85'	77.54	174,530.64	145,701.92
E	1388'	28°52'47"	408.91'	800.43	174,488.27	144,614.75

**RAMP NO. 3**

R	Δ	T	L
A	7'	94°05'06"	7.52'
B	37'	85°54'54"	34.45'

(103+53.39 & Dam)  
CCM 167.45  
641+99.92 BC  
646+12.80 Fwy  
Nothing Set  
Per USED N7AP

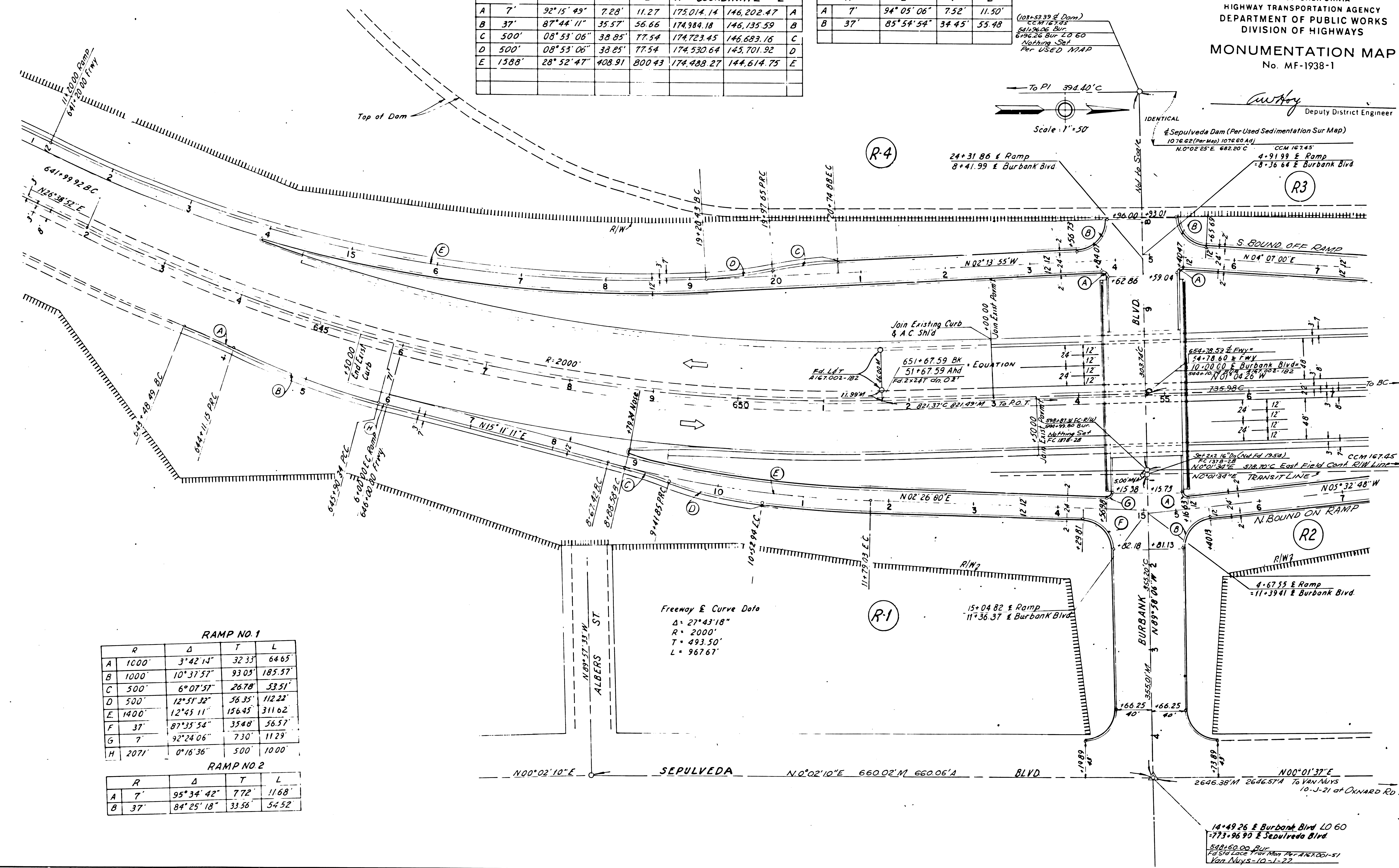
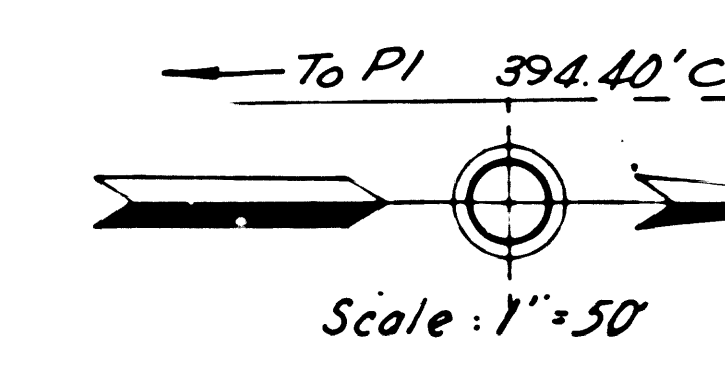

**RAMP NO. 1**

R	Δ	T	L
A	1000'	3°42'14"	32.35'
B	1000'	10°37'57"	93.05'
C	500'	6°07'57"	26.78'
D	500'	12°51'32"	56.35'
E	1400'	12°45'11"	156.45'
F	37'	87°35'54"	35.48'
G	7'	92°24'06"	7.30'
H	2071'	0°16'36"	500' 10.00'

**RAMP NO. 2**

R	Δ	T	L
A	7'	95°34'42"	7.72'
B	37'	84°25'18"	33.56'

Freeway & Curve Data  
Δ = 27°43'18"  
R = 2000'  
T = 493.50'  
L = 967.67'

149-15



STATE OF CALIFORNIA  
HIGHWAY TRANSPORTATION AGENCY  
DEPARTMENT OF PUBLIC WORKS  
DIVISION OF HIGHWAYS  
**MONUMENTATION MAP**  
No. MF-1938-2

*Anthony*  
Deputy District Engineer

**RAMP NO. 3**

R	Δ	T	L	
C	500'(E)	8°53'06"	38.85'	77.54'
D	500'(W)	8°53'06"	38.85'	77.54'
E	3500'	11°16'48"	345.65'	689.06'

**RAMP NO. 2**

R	Δ	T	L	
C	500'(W)	8°53'06"	38.85'	77.54'
D	500'(E)	8°53'06"	38.85'	77.54'

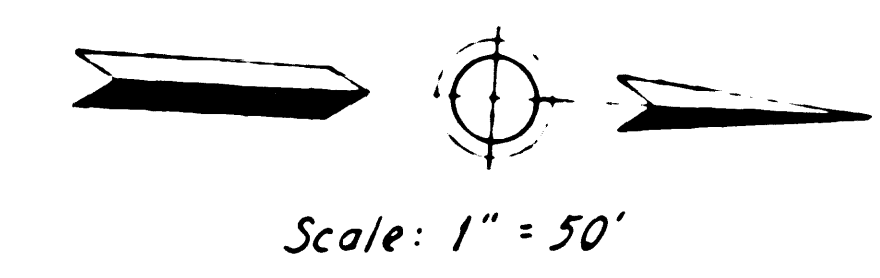

**S. BOUND OFF RAMP**  
CURVE DATA  
Δ = 21°35'04"  
R = 3500'  
T = 667.17'  
L = 1318.52'

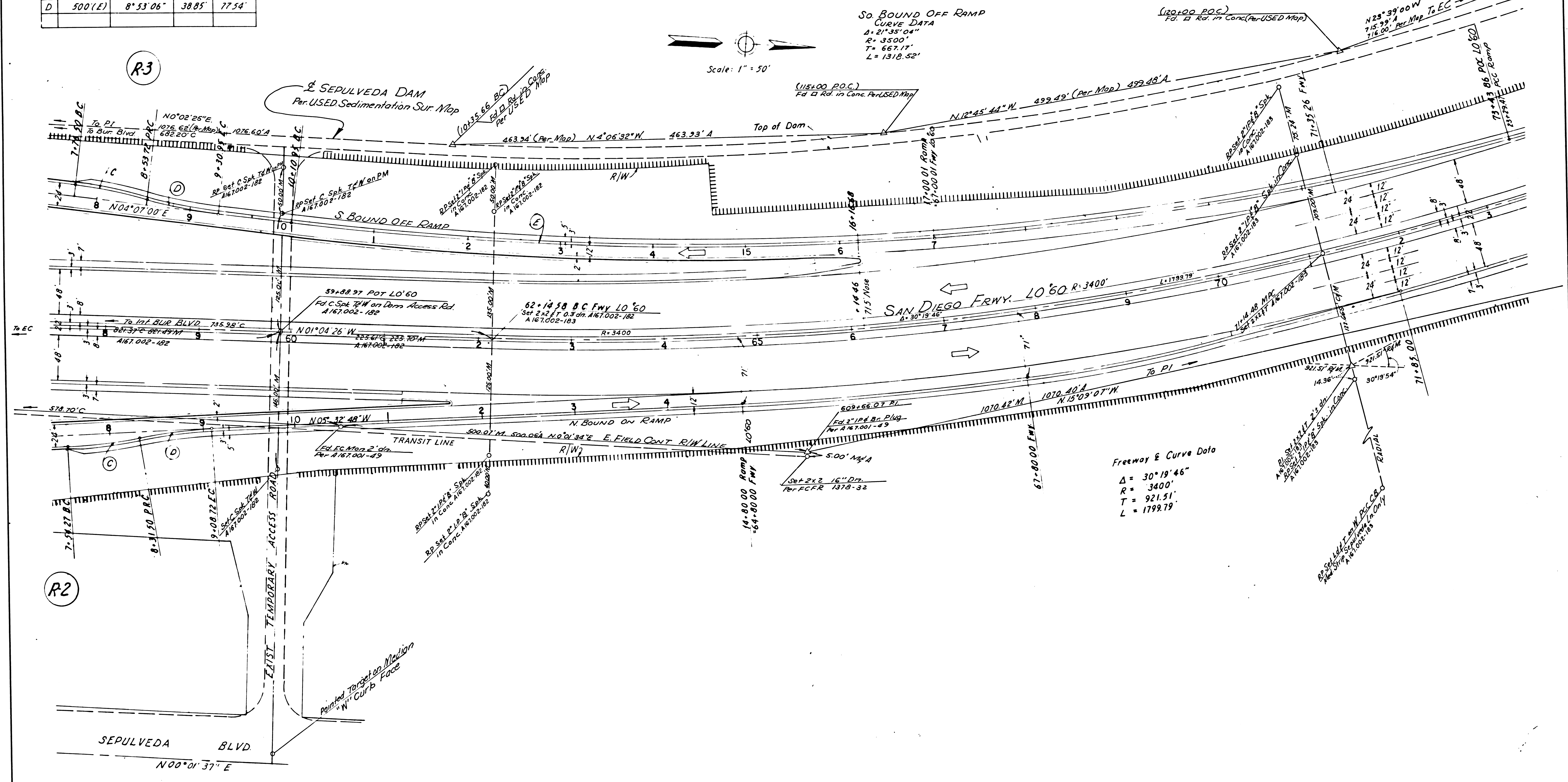

**Freeway E Curve Data**  
Δ = 30°19'46"  
R = 3400'  
T = 921.51'  
L = 1799.79'

R2

SEPULVEDA BLVD  
N00°01'37" E

149-15

DIST	COUNTY	NO. 10	POST MILES - TOTAL PROJECT	SHEET	TOTAL SHEETS
7	LA	405	40.28 / 45.00	3	17

STATE OF CALIFORNIA  
HIGHWAY TRANSPORTATION AGENCY  
DEPARTMENT OF PUBLIC WORKS  
DIVISION OF HIGHWAYS  
MONUMENTATION MAP  
No. MF-1938-3

*Cawthoy*  
Deputy District Engineer

RAMP NO. 3

R	Δ	T	L	
F	1500'	4°47'05"	62.67'	125.26'

Freeway Curve Data  
R=3400'  
Δ=30°19'46"  
L=1799.79'  
T=921.51'

SEPULVEDA DAM  
Per USED Sedimentation Sur. Map.

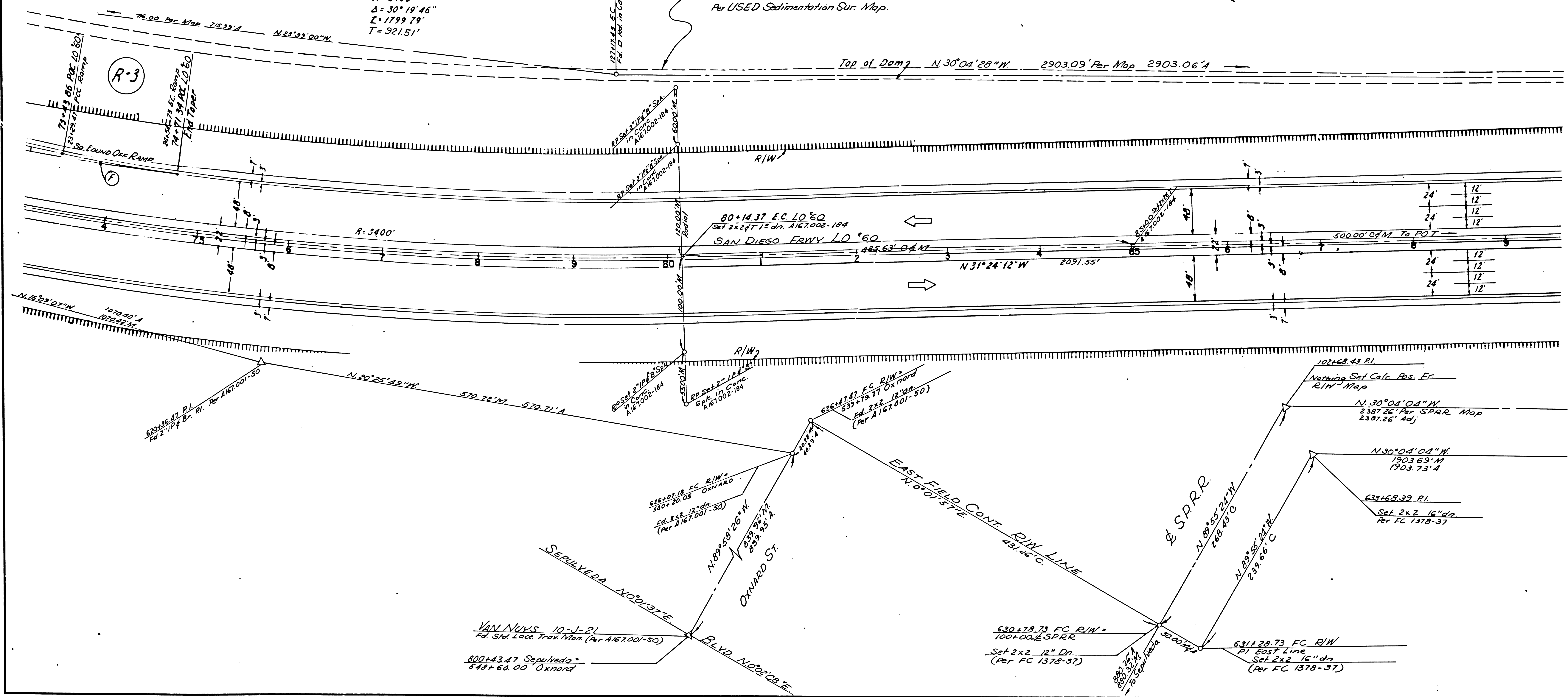
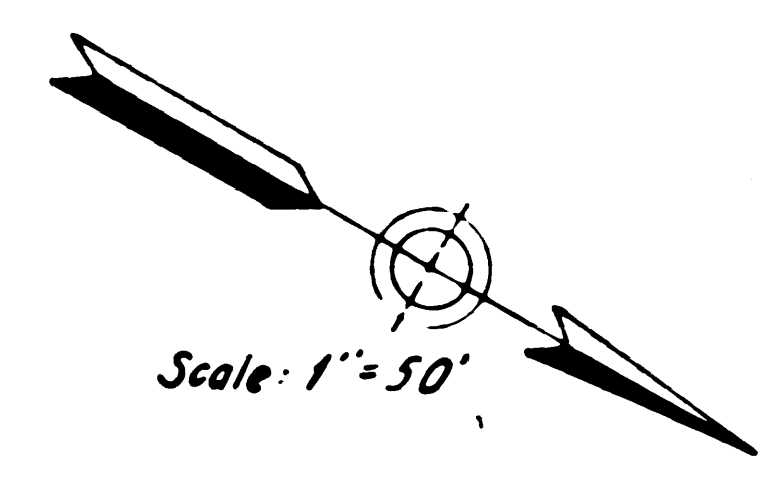

149-15







DATE	COUNT	NO. 18	POST MILES - TOTAL PROJECT	SHEET	TOTAL
7	LA	405	40.28 / 45.00	5	17

STATE OF CALIFORNIA  
HIGHWAY TRANSPORTATION AGENCY  
DEPARTMENT OF PUBLIC WORKS  
DIVISION OF HIGHWAYS

MONUMENTATION MAP  
No. MF-1938-5

*awt*  
Deputy District Engineer

RAMP NO. 1

R	Δ	T	L	
A	750'	06°22'00"	41.71'	83.34'
B	288'	64°35'00"	182.00'	324.63'

RAMP NO. 5

R	Δ	T	L	
A	600'	9°43'17"	51.02'	101.80'
B	600'	5°35'46"	29.32'	58.60'
C	1250'	18°45'56"	206.55'	409.40'

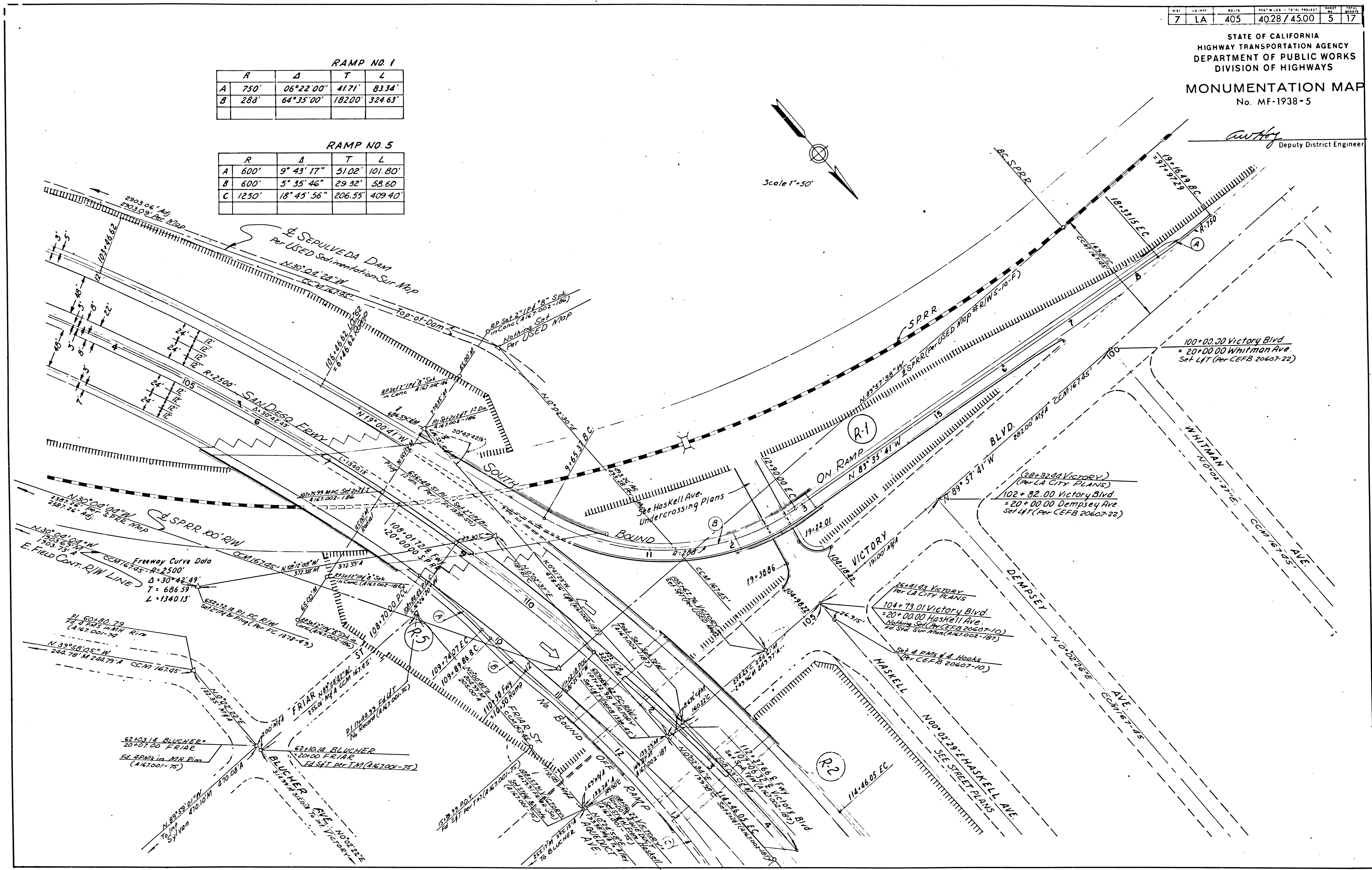
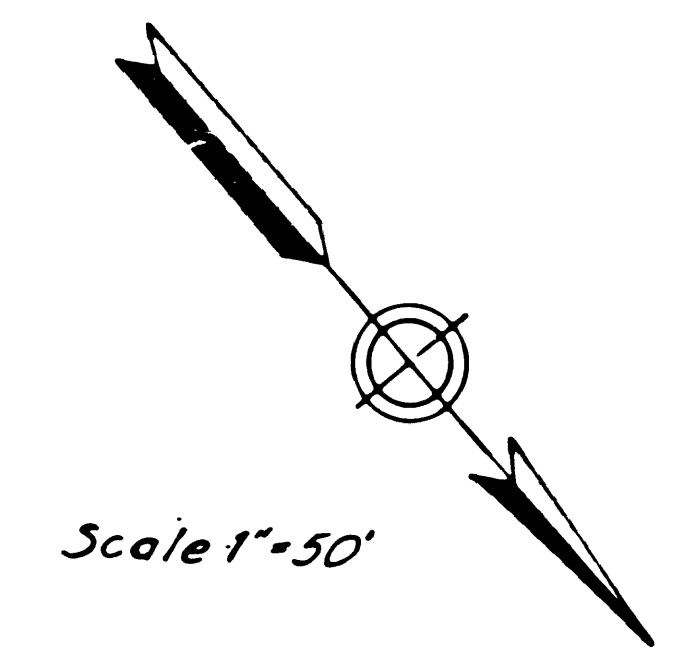

149-15